

WoodWorks Index of Mass Timber Connections



This index is a compilation of connections used in mass timber construction. Mass timber elements are solid wood pieces with inherent fire resistance due to their mass, as defined in the 2021 International Building Code (IBC). Examples of mass timber include but are not limited to cross-laminated timber (CLT), dowel-laminated timber (DLT), nail-laminated timber (NLT), glue-laminated timber (GLT), mass plywood panels (MPP), and structural composite lumber (SCL) products such as laminated veneer lumber (LVL) and laminated strand lumber (LSL). Mass timber can be used as structural floors, roofs, walls, columns and/or beams. The examples in this index illustrate a broad spectrum of connections for use in mass timber construction. Depending on the unique constraints of each project, the connection choice made by the designer may be influenced by aesthetics, load carrying capacity, fire-rating requirements, quality assurance requirements, cost and/or constructability. The purpose of the index is to facilitate the designer's selection of project-appropriate connections.

The index includes structural and architectural connections created for WoodWorks by **KL&A Engineers & Builders** and **Oz Architecture** in cooperation with **Swinerton Builders**. For information on these firms and their mass timber projects, follow the links above to view their profiles on the WoodWorks Innovation Network.

FREE PROJECT SUPPORT | EDUCATION | RESOURCES

For free technical assistance related to mass timber connections, or any aspect of the design, engineering or construction of a commercial or multi-family wood building in the U.S., visit woodworks.org to contact the WoodWorks Regional Director nearest you or email help@woodworks.org.



Table of Contents

PUBLISH DATE: MAY 14, 2021 / UPDATED AUGUST 24, 2021

Mass Timber Design Notes	5
Connection Design Resources	7

Structural Connections

Structural Connections Nomenclature	8
--	---

Table 1: Mass Timber Panel to Mass Timber Panel

1-1 Panels Connect with Single Surface Spline	10
1-2 NLT or DLT Panels Connect with Single Surface Spline	10
1-3 Panels Connect with Steel Surface Spline	11
1-4 Panels Connect with Half-Lap Joint	11
1-5 Panels Connect with Screws Across Butt Joint	11
1-6 Panels Connect with Tube Connectors	012

Table 2: Mass Timber Panel Support at Mass Timber Beam

2-1 Panel Bears on Beam	13
2-2 Panel Bears on Beam at Notch	13
2-3 Panel Bears on Ledger at Beam	14
2-4 Panel Bears on Bracket at Beam	14

Table 3: Mass Timber Panel Point Support at Mass Timber Column

3-1 Panel Bears on Column	15
3-2 Floor Panel Bears on Column at Bracket	15
3-3 Floor Panel Bears on Column at Standoff	16
3-4 Floor Panel Bears on Column at Proprietary Standoff	17
3-5 Floor Panel Bears on Column at Proprietary Standoff with Panel Reinforcement	17

Table 4: Mass Timber Panel Support at Mass Timber Wall Panel

4-1 Floor Panel Bears on Wall – Platform	18
4-2 Roof Panel Bears on Wall – Platform	18
4-3 Roof Panel Bears on Wall – Platform with Bracket	19
4-4 Floor Panel Bears on Wall – Platform with Brackets	19
4-5 Floor Panel Bears on Wall – Platform with Side Plate	20
4-6 Floor Panel Bears on Wall – Platform with Concealed Plates	20
4-7 Floor Panel Bears on Wall – Platform with Proprietary Connectors	20
4-8 Floor Panel Bears on Ledger – Balloon	21
4-9 Floor Panel Bears on Bracket – Balloon	21

Table 5: Mass Timber Panel Support at Concrete or Masonry

5-1 Panel Bears at Top of Wall	22
5-2 Panel Bears on Bracket at Wall	22
5-3 Panel Bears on Leger at Wall	23
5-4 Panel Bears on Bracket at Wall with Collector Plate	23
5-5 Panel is Supported by Proprietary Connector (Simpson Holdown Detail)	24

Table 6: Mass Timber Panel Support at Light Frame

6-1 Roof Panel Bears on Top of Wall	25
6-2 Floor Panel Bears on Wall – Platform with Non-Fire-Resistance-Rated Wall	26
6-3 Floor Panel Bears on Wall – Platform with Fire Retardant-Treated Walls	26
6-4 Floor Panel Bears on Ledger – Balloon	27

Table 7: Mass Timber Panel Support at Steel Beam

7-1 Panel Bears on Steel Beam	28
7-2 Panel Bears on Steel Beam with Angles	29
7-3 Panel Hung from Beam with Bolts	29
7-4 Panel Bears on Bottom Flange of Steel Beam	30
7-5 Panel Bears on Proprietary Composite Steel Support	30

Table 8: Mass Timber Beam Support at Mass Timber Girder

8-1	Beam Bears on Girder.....	31
8-2	Beam Bears in Girder with Notch.....	31
8-3	Beam Bears on Steel Bearing Seat with Knife Plate.....	32
8-4	Beam Bears on Concealed Steel Bearing Plate with Knife Plate.....	33
8-5	Beam Bears on Steel Bearing Seat with Side Plates (Bucket).....	33
8-6	Beam Connected to Girder with Proprietary Hanger.....	34
8-7	Beam Connected to Girder with Concealed Face-Mounted Knife Plate Connector.....	34
8-8	Beam Connected to Girder with Steel Angles.....	34
8-9	Beam Connected to Girder with Proprietary Concealed Connectors.....	35
8-10	Dovetail.....	35
8-11	Beam Splice with Steel Plate Scarf Joint.....	36

Table 9: Mass Timber Beam Support at Mass Timber Column

9-1	Beam Bears on Column.....	37
9-2	Beam Bears on Column with Knife Plate.....	37
9-3	Beam Bears on Column at Notch.....	38
9-4	Multiple Beams Bear on Column Collar.....	38
9-5	Multiple Beams Bear on Column at Notches.....	39
9-6	Multiple Beams Bear on Combined Bearing Plate & Beam Hanger.....	40
9-7	Multiple Beams Bear on Girders on Notched Column.....	41
9-8	Multiple Beams Bear on Bearing late with Steel Standoff Supporting Column Above.....	41
9-9	Multiple Beams Bear on Girders on Bearing Plate with Steel Standoff Supporting Column Above.....	42
9-10	Column and Beam Bear on Column at Custom Standoff.....	43
9-11	Beam Bears on Steel Bearing Seat with Knife Plates on Column.....	43

Table 10: Mass Timber Beam Support at Mass Timber Wall Panel

10-1	Beam Bears on Mass Timber Wall Panel.....	44
10-2	Beam Bears on Mass Timber Wall Panel at Pocket.....	44

Table 11: Mass Timber Beam Support at Concrete or Masonry

11-1	Beam Perpendicular to Wall Connected to Face of Wall.....	45
11-2	Beam Perpendicular to Wall Connected to Face of Wall with Top Bearing.....	45
11-3	Beam Bears at Top of Column or Wall.....	46
11-4	Beam Parallel to Wall Connected to Face of Wall with Top Bearing.....	46
11-5	Beam Bears on Pilaster.....	46
11-6	Beam Bears in Wall Pocket.....	47
11-7	Beam Supported by Knife Plate.....	47

Table 12: Mass Timber Supporting Light Frame Systems

12-1	Truss Bears on Wall Panel Pocket – Balloon-Framed.....	48
12-2	I-Joist Bears on Hanger – Balloon-Framed.....	49

Table 13: Mass Timber Supporting Steel Frame Systems

13-1	Beam Bears on Mass Timber Wall Panel.....	50
13-2	Beam Bears on Mass Timber Wall Panel at Pocket.....	50
13-3	Beam Supported by Shear Tab – Balloon-Framed.....	51
13-4	Post Bears on Panel.....	51
13-5	Beam Bears on Top of Wood Column.....	52
13-6	Beam Bears on Top of Wood Column with Angle.....	52
13-7	Beam Top Flange Bears on Wood Column.....	53

Table 14: Mass Timber Wall Panel to Mass Timber Wall Panel

14-1	Panels Connect with Screws – Perpendicular Intersection.....	54
14-2	Panels Connect with Brackets – Perpendicular Intersection.....	54
14-3	Panels Connect with Half-Lap Joint – Perpendicular Intersection.....	55
14-4	Panels Connect with Slot Connector.....	55
14-5	Panels Connect with Single Surface Spline.....	56
14-6	Panels Connect with Double Surface Spline.....	56
14-7	Panels Connect with Internal Spline.....	57
14-8	Panels Connect with Half-Lap Joint.....	57
14-9	Panels Connect with Screws Across Butt Joint.....	58
14-10	Panels Connect with Epoxied Steel Rod – Horizontal Splice.....	58
14-11	Panels Connect with Steel Plate – Vertical Splice.....	58

Table 15: Mass Timber Column Base at Concrete

15-1	Column Bears with Knife Plate	59
15-2	Column Bears with Side Plates	59
15-3	Column Bears with Custom Standoff.....	60
15-4	Column Bears with Adjustable Standoff Base	61
15-5	Column Bears with Proprietary Dowel Connector	61
15-6	Column Bears with Proprietary Plate Connector	61
15-7	Column Bears with Proprietary Adjustable Column Base.....	62

Table 16: Mass Timber Wall Panel Base at Concrete

16-1	Panel Bears with Sill Plate	63
16-2	Panel Bears with Side Plate.....	63
16-3	Panel Bears with Bracket.....	64
16-4	Panel Bears with Buckets.....	64
16-5	Panel Bears with Continuous Proprietary Shoe	65
16-6	Panel Bears with Knife Plates.....	65
16-7	Panel Holddown.....	66
16-8	Panel Holddown with Rod System.....	66
16-9	Panel Holddown with Multi-Story Rod System.....	67
16-10	Panel Holddown with Proprietary Connection System	67

Architectural Connections

Architectural Connections Nomenclature	68
---	-----------

Table 17: Floor/Ceiling Assemblies

17-1	Typical 3-Ply CLT Floor/Exposed Ceiling Assembly	69
17-2	Typical 5-Ply CLT Floor with Raised Plenum Floor/Concealed Ceiling.....	69
17-3	Typical 5-Ply CLT Floor with Concealed Ceiling	70

Table 18: Roof Details

18-1	Typical Roof Assembly with Rigid Insulation & TPO*	71
18-2	Roof Drain and Overflow at CLT Roof Deck.....	71
18-3	Conduit/Pipe Penetration at CLT Roof Deck	72
18-4	Roof Tie-Off at Typical Roof Assembly	72

*Thermoplastic polyolefin

Table 19: Wall Details

19-1	Shaft Wall Assembly at Non-Rated Floor & 2-Hr Shaft.....	73
19-2	Shaft Wall Assembly at 1-Hr-Rated Floor & 1-Hr Shaft	73
19-3	Shaft Wall Assembly at Bottom of Shaft with Beam Support	74
19-4	Shaft Wall Assembly at Bottom of Shaft with HSS Support	74
19-5	Shaft Wall Assembly at Non-Rated Floor and 1-Hr Shaft with Concrete Turned Down Beam	75
19-6	Shaft Wall Assembly at Non-Rated Floor & 2-Hr Shaft with Concrete Turned Down Beam	75
19-7	CLT Hung Support Hung from Underside of CLT Floor.....	76
19-8	Typical Interior Demising Wall	76
19-9	Exterior Brick Wall Attachment to CLT Floor.....	77
19-10	Curtain Wall Attachment to Rated Floor.....	77
19-11	Curtain Wall Attachment to Non-Rated Floor.....	78
19-12	Curtain Wall Attachment to Non-Rated Floor at Overhang.....	78
19-13	Curtain Wall Attachment to Non-Rated Roof	79
19-14	Exterior Wall Attachment to CLT Floor at Glazed Openings	79
19-15	CLT Terrace at Curtain Wall Curb with Pavers.....	80

Disclaimer: The information in this publication, including, without limitation, references to information contained in other publications or made available by other sources (collectively “information”) should not be used or relied upon for any application without competent professional examination and verification of its accuracy, suitability, code compliance and applicability by a licensed engineer, architect or other professional. Neither the Wood Products Council nor its employees, consultants, nor any other individuals or entities who contributed to the information make any warranty, representative or guarantee, expressed or implied, that the information is suitable for any general or particular use, that it is compliant with applicable law, codes or ordinances, or that it is free from infringement of any patent(s), nor do they assume any legal liability or responsibility for the use, application of and/or reference to the information. Anyone making use of the information in any manner assumes all liability arising from such use.

Mass Timber Design Notes

Mass timber structures are a unique building type requiring consideration of concepts that may be unique to mass timber and not considered in the design of connections for other materials. The following is an overview of some of these considerations, but should not be considered an exhaustive list. It is the responsibility of the designer to ensure that the connection design accounts for all necessary criteria.

Mass Timber Panels, Beams and Columns:

A unique aspect of mass timber construction is that some materials and members are not standardized. Products available from different suppliers may vary by species, geometry and available maximum fabrication size. These factors may be important constructability, cost and/or aesthetic considerations for a project. Selection of a supplier early in the design process, although not always feasible, can be extremely helpful. Panel types can include CLT, DLT, NLT, GLT and SCL-CLT. In most cases, a supplier will manufacture only one panel type. Conversations with the supplier early in design can also help to determine optimal grid sizes, preferred connection geometries, and methods to reduce construction costs. For example, in panel manufacturing, a connection that requires the panel to be flipped during manufacture will be more expensive than a panel that can be fabricated without flipping it over.

Discussions with the mass timber supplier and contractor are useful to determine their fabrication capabilities and construction preferences. In mass timber construction, it is often desirable for holes, notches and any other alterations to be made in the member during fabrication instead of on site. Many fabricators can also produce complex geometries in the shop that could be difficult to achieve on the jobsite.

Fabrication tolerances for mass timber are extremely precise and might be as low as +/- 1/16-in. Tolerances for other materials such as steel, concrete and/or masonry can be larger. In most structures, there will be some interface between mass timber and these other materials. It is therefore important to consider the effects of these relative construction tolerances.

Fasteners:

Many connections in mass timber construction are connected using dowel-type fasteners, including bolts, screws, nails and pins. Detailed guidance on these fasteners is found in the American Wood Council's (AWC's) *National Design Specification® (NDS®) for Wood*

Construction, Chapter 12. The required fastener for a given connection will depend on the connection geometry and loading conditions, as well as contractor, architect and fabricator input. For many connections shown in the index, especially those distributed over long joints, connection capacity can be increased or decreased simply by adjusting the size and spacing of fasteners.

Screws are the most common fastener used in mass timber connections. However, where nails work instead of screws, they are easier and less expensive to install. It is also worth considering specifying nail gun-compatible nails instead of common nails and collated screws instead of individual screws for ease of installation. Where screws are used in a connection, they can be either lag or proprietary screws, and many fabricators have preferred screw manufacturers. Screw suppliers include Simpson Strong-Tie, Rothoblaas, MiTek, MTC Solutions, GRK Fasteners and others. Requirements for lag screw installation are covered in the NDS. Proprietary screws are as specified by the manufacturer and are typically self-tapping. For mass timber projects, screw sizes are generally 1/4-in. in diameter and greater and are available in a wide range of lengths. Installers tend to prefer smaller-diameter screws where possible because they are easier to install. Smaller screws may also be advantageous for the designer because larger screw diameters have greater edge distance and spacing requirements. In many cases, it is possible to use smaller edge distances and spacing when screw holes are pre-drilled, but this can add expense to the project. It is important to ensure that fasteners are not loaded in withdrawal from the end grain of members, as specified in the NDS. This can be challenging on the edges of CLT panels, where every other ply presents end grain and there are tight constraints due to edge distance requirements.

There are two primary screw types to choose from: partially-threaded and fully-threaded. Partially-threaded screws are more common in mass timber construction and have a smooth shaft between the screw head and the threads, whereas fully-threaded screws have threads along their entire length. Partially-threaded screws are used for fastening two members together, and work to pull the two members together. Ideally, the threads will be fully embedded in the main member. Fully-threaded screws are used where thread withdrawal capacity is required either on both sides of a connection joint or a possible failure plane within a single member. Fully-threaded screws do not pull two members together as partially-threaded screws do, and improper installation can create a gap. Fully-threaded screws can also restrain members differently than partially-threaded screws when the member shrinks. Additional information on fully versus partially-threaded screws can be found in MTC Solutions' *Structural Screw Design Guide*.

In some cases, diagonally-oriented screws are desired for a connection. To aid in installation, a jig can be used to achieve the correct angle, or it may be preferable to pre-drill the side (outer) member of the connection in the shop where precise locations and angles can be achieved. In diagonal applications, it is also important to ensure accurate installation so the screw does not penetrate through to the opposite surface of the member, where it can impact the member aesthetics. Diagonally-oriented screws are typically designed to carry load through axial tension in the screw, which results in lower connection ductility than screws in shear. This is not recommended in high-seismic zones.

When attaching to concrete or masonry, a connection can be achieved with either embedded or post-installed anchors. The connection location, geometry and contractor preference will drive which connection type is more appropriate for a given location. The design of such attachments should consider minimum edge distances and spacing requirements as specified by the supplier, the American Concrete Institute *ACI-318 Building Code Requirements for Structural Concrete* and/or The Masonry Society (TMS 402) *Building Code Requirements for Masonry Structures*. Embedded anchors are capable of greater capacities, but it is often difficult to ensure correct placement of embedded items in concrete. Post-installed anchors generally have more placement flexibility but can be difficult to install in areas of congested reinforcement.

Moisture:

An important consideration in mass timber connection design is the ability to accommodate expected dimensional changes in wood due to moisture. This includes both wood shrinkage associated with exposure to dry environments and wood swelling associated with exposure to moist environments. The magnitude of dimensional change in wood is greater in the perpendicular-to-grain direction than the parallel-to-grain direction. Mass timber elements, which are typically large in thickness or cross section, may therefore be subject to significant dimensional change. It is the designer's responsibility to consider the effect of these movements in connection design for both short- and long-term conditions and the interface of wood adjacent to steel, concrete or masonry components.

Moisture also impacts fastener placement. In many screw applications, it may be beneficial to countersink the screw slightly to account for moisture-induced shrinkage/swelling over time. Additionally, where a connection calls for multiple dowel-type fasteners in the face of a member, the designer should account for shrinkage/swelling of the member with respect

to fastener location and spacing. More information can be found in APA – The Engineered Wood Association's (*EWS*) *T300 Glulam Connection Details Construction Guide*. It should be noted that changes in moisture content can also reduce the lateral design values per NDS Table 11.3.3.

Mass timber elements themselves are also susceptible to damage due to moisture. Damage can occur both during construction and beyond and can be aesthetic, structural or both. Moisture infiltration can discolor the wood directly or by contact with unprotected metal connection components and, when subjected to long-term moisture, the capacity of the wood can be reduced. It is important to consider moisture protection in construction and in locations where the wood members may be exposed to moisture over the lifetime of the structure.

Aesthetics:

Mass timber design may require an additional level of coordination with the architect, interior designer and owner. One of the primary benefits of mass timber construction is the ability to expose the wood architecturally. Decisions normally made by the structural engineer, such as member size, wood grade, species and connection appearance have aesthetic impacts that are generally not exposed with other structural material types.

In some projects, a concrete topping over the floor panel will remain exposed. In this index, toppings and other architectural finishes are not indicated. Although this topping is generally non-structural, the designer may still want to consider specifying reinforcing to control shrinkage and cracking in the concrete.

Using the Index:

All connections represented in the index are conceptual only and must be designed by a licensed professional engineer in accordance with locally-adopted codes before being incorporated into a structure. Images in the index are intended to show a broad spectrum of mass timber connections. The connections show primary and secondary load paths; however, the connections may need to meet other structural and performance requirements, such as seismic drift or other deflection criteria. It is the responsibility of the designer to ensure that connections are designed for all appropriate geometries and loads. This document is not intended to replace the building code and well-established industry standards for connection design.

Connection Design Resources

The following resources may be useful in mass timber connection design:

- American Institute of Steel Construction, *Manual of Steel Construction*
- American Institute of Timber Construction, *AITC Technical Note 19 Guidelines for Evaluation of Holes and Notches in Structural Glued Laminated Timber Beams*
- American Society of Civil Engineers, (ASCE/SEI 7) *Minimum Design Loads and Associated Criteria for Buildings and Other Structures*
- American Wood Council (AWC), *National Design Specification® (NDS®) for Wood Construction with Commentary*
 - Chapter 5 *Structural Glued Laminated Timber*
 - Chapter 9 *Wood Structural Panels*
 - Chapter 10 *Cross-Laminated Timber*
 - Chapter 11 *Mechanical Connections*
 - Chapter 12 *Dowel-Type Fasteners*
 - Chapter 16 *Fire Design of Wood Members*
- American Wood Council (AWC), *Calculating the Fire Resistance of Wood Members and Assemblies Technical Report No. 10 (TR 10)*
- American Wood Council (AWC), *DCA 3 - Fire-Resistance-Rated Wood-Frame Wall and Floor/Ceiling Assemblies*
- American Wood Council (AWC), *Wood Construction Data 5 (WCD5) Heavy Timber Construction*
- APA – The Engineered Wood Association, *APA EWS T300 Glulam Connection Details Construction Guide*
- Binational Softwood Lumber Council, *Nail-Laminated Timber U.S. Design & Construction Guide*
- FPInnovations, *CLT Handbook*, Canadian Edition
- FPInnovations, *CLT Handbook*, U.S. Edition
- International Building Code
 - Chapter 6 *Types of Construction*
- MTC Solutions, *ASSY Screws as Tensile Reinforcement in Notched Beams*
- MTC Solutions, *Full Thread SWG ASSY Screws in Reinforcement*
- MTC Solutions, *Structural Screw Design Guide*
- The Masonry Society, *(TMS 402) Building Code Requirements for Masonry Structures*

Structural Connections Nomenclature

Each connection in the index is categorized as follows:

- **Connection Type :** Brief description of the connection in terms of the primary load path.
- **Image:** Graphic showing the members and pieces of the connection. For most connections that include a panel member, it is shown as CLT. In most of the connections, CLT is interchangeable with DLT, NLT or SCL-CLT without any change to the connection. Where a connection is specific to the panel type, it is stated in the Designer Notes.

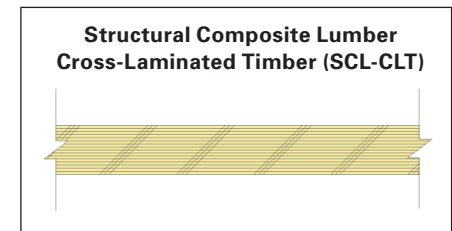
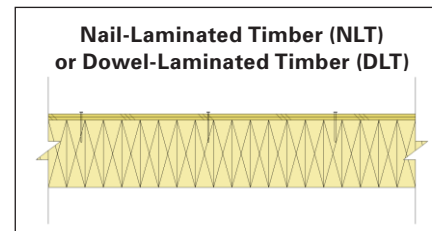
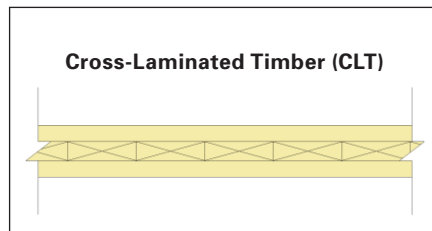

- o → ⊙ ⊗
- o → ⊙ ⊗
- o → →
- o ⊗ ⊗
- o ⊙ ⊙

Red symbols indicate the primary load path and direction for the connection.

Light blue symbols indicate the secondary load paths and directions for the connection.

Loads across the page.

Loads into the page.

Loads out of the page.

- **Designer Notes:**

- o Purpose: The main function and load path of the connection. Secondary load paths may also be present and analysis of the resulting load combinations may be required.
- o Description: Describes how the connection is constructed.
- o Notes: Important considerations for the designer, such as alternates, suggestions and potential challenges in design and construction.
- o Other Applications: Points to other sections in the index where the same connection with a different supporting member applies.

- **Connections Class (Class):** Connection class differentiates the components required to make a connection.
 - o Class 1 Connection only requires wood members and fasteners.
 - o Class 2 Connection requires custom steel fabricated elements such as steel angles, plates and fasteners.
 - o Class 3 Connection uses proprietary connectors available from suppliers such as Simpson Strong-Tie, Rothoblaas, MiTek and others.

- **Load-Carrying Capacity (Load):** Expresses the load-carrying capacity of the connection for the primary load path relative to similar connections. Load carrying capacity is qualitatively defined as low, medium or high and is based on applicable building codes and fastener/connector manufacturer's literature. This rating does not consider member or connection deflections, which should be accounted for by the designer. In addition, versions of each connection may have higher or lower capacities than the average design. Therefore, there may be some overlap in connection capacity depending on the application.

- **Connection Cost (Cost):** Expresses the cost of the connection relative to other connections within the given table. Connection cost is ranked from \$ to \$\$\$\$\$. The designer should consider the cost of a connection from a global perspective. In some cases, the cost of a connection can be offset by other variables such as member size, capacity or constructability.

- **Constructability (Const):** Expresses the relative ease of constructing the connection. Constructability is ranked as easy, moderate or advanced.

- **Inspectability (Inspect):** Expresses the ease of inspecting the connection once the connection is completed.
 - o Easy All fasteners and/or connectors in the primary load path are visible.
 - o Advanced Some or all fasteners and/or connectors in the primary load path are hidden.

- **Fire Rating:** Fire rating of connections may be required based on the building type (IBC Chapter 6) and/or local jurisdiction requirements. If a connection is not categorized as rated in this index, the connection may have been tested and rated since the writing of the index, or may have been tested and rated without the results being made public. Ultimately, acceptability of fire rating is determined by the Authority Having Jurisdiction (AHJ). For this index, it is assumed that steel beams are themselves rated, and the fire-rating classification is for the connection only.
 - o Level I A version of this connection has been rated through testing at the time of publishing this index. Connections identified as 'rated' are specified in the manufacturer's literature or included in the *WoodWorks Inventory of Fire Resistance-Tested Mass Timber Assemblies & Penetrations*. Some rated assemblies may include a topping that is not indicated in this index.
 - o Level II It is possible that the connection as shown in the index is inherently fire resistant and may meet fire-rating requirements. The addition of fire caulking, grout or sealing may be required. Verification of fire-rating resistance is in accordance with tested or calculated assemblies as specified in the IBC.
 - o Level III Connection includes exposed steel components requiring protection to achieve the desired fire-resistance rating. In many cases, fire-rating requirements can be met by concealing a connection using wood, concrete, gypsum or other approved materials. Methods of protection may include spray fireproofing or intumescent paint. Guidance on fire rating can be found in the American Wood Council's (AWC's), *Calculating the Fire Resistance of Wood Members and Assemblies Technical Report No. 10 (TR 10)* and the 2021 IBC.

Table 1: Mass Timber Panel to Mass Timber Panel

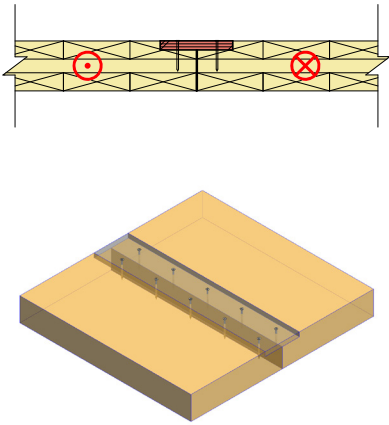
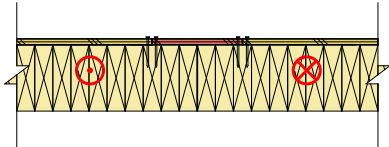
Connection Type	Image	Designer Notes	Class	Load	Cost	Const	Inspect	Fire
<p>1-1.</p> <p>Panels Connect with Single Surface Spline</p>		<p>Purpose: Transfer of in-plane shear along the panel-to-panel joint.</p> <p>Description: Adjacent floor panels with routed surfaces are butted together. A plywood spline is fastened to both panels using partially-threaded screws or nails.</p> <p>Notes:</p> <ul style="list-style-type: none"> • Capacity of connection is controlled by shear capacity of dowel-type fasteners. • Double surface spline or steel surface spline can be used for increased capacity. • Spline may be fully above panels without routed surface where floor or roof coverings allow. • Where using nails, consider specifying nail gun nails instead of common wire nails for constructability, or collated screws instead of individual screws. • Where screws are used instead of nails, cost increases and constructability is moderate. • Typical minimum plywood thickness is ½" nominal. • Coordinate spline and rout width and thickness with panel supplier. • In diaphragm design, consider that, for extreme in-plane bending, bearing in the connection will occur. It is preferable for the panels to bear on one another before bearing on the spline, which is achieved by specifying a larger gap between the spline and panel than between the two panels. 	1	Medium	\$	Easy	Easy	Level I
<p>1-2.</p> <p>NLT or DLT Panels Connect with Single Surface Spline</p>		<p>Purpose: Transfer of in-plane shear along the panel-to-panel joint.</p> <p>Description: Adjacent floor panels are butted together. A plywood spline is fastened to both panels using partially-threaded screws or nails.</p> <p>Notes:</p> <ul style="list-style-type: none"> • Capacity of connection is controlled by shear capacity of dowel-type fasteners. • Common for NLT and DLT panels. • Panels are manufactured with a layer of sheathing held back from the panel edges to accommodate splines. • Where using nails, consider specifying nail gun nails instead of common wire nails for constructability, or collated screws instead of individual screws. • Where screws are used instead of nails, cost increases and constructability is moderate. • Coordinate spline width and thickness with panel supplier. • For guidance on fasteners within panels, see the <i>Nail-Laminated Timber U.S. Design & Construction Guide</i>. 	1	Medium	\$	Easy	Easy	Level I

Connection Type	Image	Designer Notes	Class	Load	Cost	Const	Inspect	Fire
1-3. Panels Connect with Steel Surface Spline		<p>Purpose: Transfer of in-plane shear along the panel-to-panel joint.</p> <p>Description: Adjacent floor panels are butted together. A steel spline is fastened to both panels using partially-threaded screws or nails.</p> <p>Notes:</p> <ul style="list-style-type: none"> • Capacity of connection is controlled by shear capacity of dowel-type fasteners. • Spline will likely be above panels without routed surface. Designer to ensure floor or roof coverings allow for this. • Screws are more common for this connection. Nails may be used for light-gauge steel splines. • Steel splines are more common with SCL-CLT applications. 	2	High	\$\$	Easy	Easy	Level III
1-4. Panels Connect with Half-Lap Joint		<p>Purpose: Transfer of in-plane shear along the panel-to-panel joint.</p> <p>Description: Adjacent floor panels with compatible notches are lapped and connected using partially-threaded screws or nails.</p> <p>Notes:</p> <ul style="list-style-type: none"> • Capacity of connection is controlled by shear capacity of dowel-type fasteners. • Orientation of the notches will determine the construction sequence. • Screws are more common than nails, in particular as panel thickness increases. • Notch width is generally controlled by screw edge distance requirements, which vary by manufacturer. • Possible, but not recommended, to be designed to carry gravity loads across joint. Reinforcing screws may be required for this application. This is outside the scope of the 2018 NDS and should only be done with careful consideration. • Inconsistencies in notch depth can cause surface variations in adjacent panels. 	1	Medium	\$\$	Moderate	Easy	Level I
1-5. Panels Connect with Screws Across Butt Joint		<p>Purpose: Transfer of in-plane shear along the panel-to-panel joint.</p> <p>Description: Adjacent floor panels are butted together and fastened with fully-threaded diagonal screws.</p> <p>Notes:</p> <ul style="list-style-type: none"> • Capacity of connection is controlled by shear capacity of dowel-type fasteners. • Jig can be used for proper installation of diagonal screws. • Pilot holes can be drilled to aid in screw installation. • Ensure that screws do not extend beyond exposed panel surface. • Fire rating is Level II for CLT panels. 	1	Low	\$\$	Moderate	Advanced	Level I

Table 1: Mass Timber Panel to Mass Timber Panel

Connection Type	Image	Designer Notes	Class	Load	Cost	Const	Inspect	Fire
1-6. Panels Connect with Tube Connectors		<p>Purpose: Transfer of in-plane shear and tension along the panel-to-panel joint.</p> <p>Description: Adjacent floor panels are butted together and secured using slotted steel tube and glued-in threaded rods.</p> <p>Notes:</p> <ul style="list-style-type: none"> • Capacity of connection is controlled by shear capacity of dowel-type fasteners and tube connector. • Connectors may have tight construction tolerance. • Refer to the <i>CLT Handbook, U.S. Edition</i> for additional information. 	2	Medium	\$\$\$-\$\$\$\$	Advanced	Advanced	Level II

Table 1: Mass Timber Panel to Mass Timber Panel

Table 2: Mass Timber Panel Support at Mass Timber Beam

Connection Type	Image	Designer Notes	Class	Load	Cost	Const	Inspect	Fire
<p>2-1.</p> <p>Panel Bears on Beam</p>		<p>Purpose: Transfer of vertical loads from roof or floor panel to wood beam. Can also transfer shear along the length of the beam.</p> <p>Description: Roof or floor panel bears on top of wood beam. Positive attachment is made with partially-threaded screws.</p> <p>Notes:</p> <ul style="list-style-type: none"> • Capacity of primary load path is controlled by perpendicular-to-grain bearing capacity of floor panel or beam. • Screws provide load path for in-plane loads. 	1	High	\$	Easy	Easy	Level II
<p>2-2.</p> <p>Panel Bears on Beam at Notch</p>		<p>Purpose: Transfer of vertical load from roof or floor panel to wood beam. Can also transfer shear along the length of the beam.</p> <p>Description: Roof or floor panel bears on notch in wood beam and is connected with partially-threaded screws.</p> <p>Notes:</p> <ul style="list-style-type: none"> • Capacity of primary load path is controlled by perpendicular-to-grain bearing capacity of floor panel or notch. • Reasonable minimum notch bearing width is 1". • Shop machined notch provides more reliable elevation control than applied bracket or ledger. • In panel design, consider that panel is not continuous across connection and multi-span conditions may not be achievable. • Beam must be designed for reduced net section. 	1	Medium	\$\$	Easy	Easy	Level I

Connection Type	Image	Designer Notes	Class	Load	Cost	Const	Inspect	Fire
<p>2-3.</p> <p>Panel Bears on Ledger at Beam</p>		<p>Purpose: Transfer of vertical load from roof or floor panel to wood beam. Can also transfer shear along the length of the beam.</p> <p>Description: Roof or floor panel bears on ledgers connected to wood beam with partially-threaded screws. Positive connection of panel to ledger is made with partially-threaded screws.</p> <p>Notes:</p> <ul style="list-style-type: none"> • Capacity of primary load path is controlled by perpendicular-to-grain bearing capacity of floor panel or ledger, or shear capacity of the ledger fasteners. • Elevation control of ledger is critical. • Screws that connect ledger to wood beam can be installed diagonally to increase capacity. • In panel design, consider that panel is not continuous across connection and multi-span conditions may not be achievable. • Best practice according to APA and AITC is for dowel-type fastener connections in the side of a mass timber beam to occur above the neutral axis. In some situations, loading can occur below the neutral axis if fully-threaded reinforcing screws are installed to resist forces that cause tension perpendicular to grain. See MTC Solutions', <i>Full Thread SWG ASSY Screws as Reinforcement</i>. 	1	Low-Medium	\$\$	Moderate	Easy	Level II
<p>2-4.</p> <p>Panel Bears on Bracket at Beam</p>		<p>Purpose: Transfer of vertical loads from roof or floor panel to wood beam. Can also transfer shear along the length of the beam.</p> <p>Description: Roof or floor panel bears on a steel angle connected to the side of the wood beam with partially-threaded screws.</p> <p>Notes:</p> <ul style="list-style-type: none"> • Capacity of primary load path is controlled by perpendicular-to-grain bearing capacity of floor panel, or shear capacity of the bracket fasteners. • Panels may be routed at angle for flush finish. • Screws and bracket provide load path for in-plane loads. • Elevation control of bracket is critical. • In panel design, consider that panel is not continuous across connection and multi-span conditions may not be achievable. • Best practice according to APA and AITC is for dowel-type fastener connections in the side of a mass timber beam to occur above the neutral axis. In some situations, loading can occur below the neutral axis if fully-threaded reinforcing screws are installed to resist forces that cause tension perpendicular to grain. See MTC Solutions', <i>Full Thread SWG ASSY Screws as Reinforcement</i>. 	2	Medium	\$\$\$	Moderate	Advanced	Level III

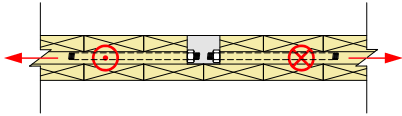
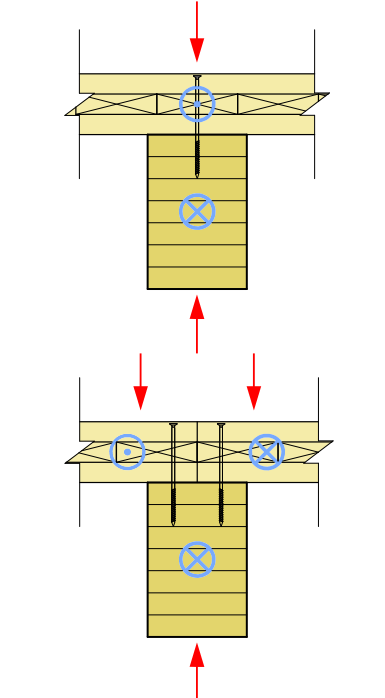
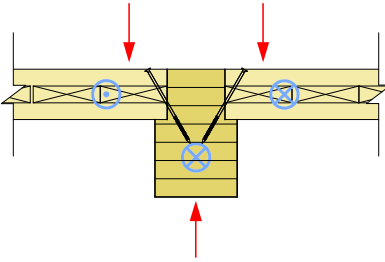
Table 2: Mass Timber Panel Support at Mass Timber Beam

Table 3: Mass Timber Panel Point Support at Mass Timber Column

The connections shown in Table 3 are unique to point support of mass timber panels with two-way spanning capability such as CLT or SCL-CLT. Two-way spanning of panels can occur in many applications but is not yet explicitly addressed in the NDS.

Connection Type	Image	Designer Notes	Class	Load	Cost	Const	Inspect	Fire
3-1. Panel Bears on Column		<p>Purpose: Transfer of vertical load from roof or floor panels to wood column.</p> <p>Description: Roof or floor panel bears on top of wood column. Positive attachment is made with partially-threaded screws.</p> <p>Notes:</p> <ul style="list-style-type: none"> • Capacity is controlled by perpendicular-to-grain bearing capacity of floor or roof panel. • This connection is unique to single-point support of mass timber panels with two-way span capability such as CLT or SCL-CLT. • If there is any net uplift on the connection, screws should be angled. • Constructability can be affected by the need for temporary bracing of column. • Panel may be continuous over column. 	1	Medium	\$	Easy	Easy	Level II
3-2. Floor Panel Bears on Column at Bracket		<p>Purpose: Transfer of vertical load from floor panels to wood column.</p> <p>Description: Roof or floor panel bears on steel brackets connected to the side of the wood column with dowel-type fasteners. Positive connection of the floor panel is made with partially-threaded screws.</p> <p>Notes:</p> <ul style="list-style-type: none"> • Capacity is controlled by perpendicular-to-grain bearing capacity of floor or roof panel, or shear capacity of the bracket attachment. • This connection is unique to single-point support of mass timber panels with two-way span capability such as CLT or SCL-CLT. • Constructability can be affected by the need for temporary bracing of column. • Designer must account for eccentricity between load and reaction. 	2	Low	\$\$	Easy	Easy	Level III

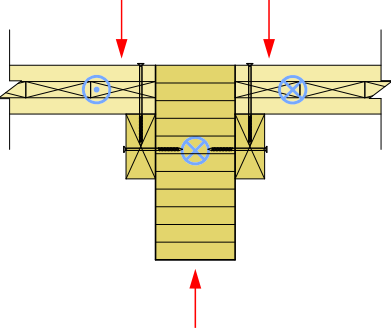
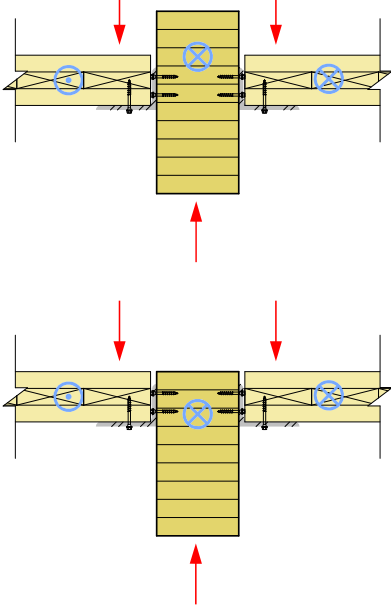
Connection Type	Image	Designer Notes	Class	Load	Cost	Const	Inspect	Fire
<p>3-3.</p> <p>Floor Panel Bears on Column at Standoff</p>		<p>Purpose: Transfer of vertical load from floor panels and upper column to wood column below.</p> <p>Description: Upper column and panels bear on standoff. Standoff bears on column below. Standoff consists of an upper bearing plate welded to an alignment guide and a lower bearing plate welded to a standoff. The alignment guide nests inside the standoff. Positive connection of bearing plates is made to columns with epoxied threaded rods or partially-threaded screws. Positive connection of panel to bearing plate is made with welded threaded rods.</p> <p>Notes:</p> <ul style="list-style-type: none"> • Capacity is controlled by perpendicular-to-grain bearing or rolling shear capacity of floor or roof panel, or as specified by manufacturer. • This connection is unique to single-point support of mass timber panels with two-way span capability such as CLT or SCL-CLT. • Constructability can be affected by the need for temporary bracing of column. • Steel connection assembly pieces are pre-installed on columns. • Consider that mechanical connection between alignment guide and standoff may be required if net uplift exists at upper column. • Proprietary options exist; possible suppliers include Rothoblaas. 	2 or 3	Medium	\$\$\$	Moderate	Easy	Level III

Table 3: Mass Timber Panel Point Support at Mass Timber Column

Connection Type	Image	Designer Notes	Class	Load	Cost	Const	Inspect	Fire
3-4. Floor Panel Bears on Column at Proprietary Standoff		<p>Purpose: Transfer of vertical load from floor panels and upper column to wood column below.</p> <p>Description: Proprietary connector is composed of an oversized bearing assembly and upper post, which fits into a larger lower post and bearing plate. The upper column bears on the oversized bearing assembly which then bears on the floor panels. The floor panels bear on the lower bearing plate. Positive connection is made between the connector and panels and between the connector and columns with screws.</p> <p>Notes:</p> <ul style="list-style-type: none"> • Capacity is controlled by perpendicular-to-grain bearing or rolling shear capacity of floor panel, or as specified by manufacturer. • This connection is unique to single-point support of mass timber panels with two-way span capability such as CLT or SCL-CLT. • Constructability can be affected by the need for temporary bracing of column. • Steel connection assembly pieces are pre-installed on the bottom of the upper column. • Possible suppliers include Rothoblaas. 	3	Medium	\$\$\$	Moderate	Easy	Level III
3-5. Floor Panel Bears on Column at Proprietary Standoff with Panel Reinforcement		<p>Purpose: Transfer of vertical load from floor panels and upper column to wood column below.</p> <p>Description: Proprietary product that connects and separates columns with a steel connection assembly. Positive connection is made to columns with screws. Floor panels bear on steel assembly and are also supported by diagonal screws in tension fastened through integral steel arms.</p> <p>Notes:</p> <ul style="list-style-type: none"> • Capacity is controlled by perpendicular-to-grain bearing or rolling shear capacity of floor panel, or as specified by manufacturer. • This connection is unique to single-point support of mass timber panels with two-way span capability such as CLT or SCL-CLT. • Constructability can be affected by the need for temporary bracing of column. • Steel connection assembly pieces are pre-installed on the bottom of the upper column. • Manufacturers include Rothoblaas. 	3	High	\$\$\$\$	Advanced	Easy	Level III

Table 3: Mass Timber Panel Point Support at Mass Timber Column

Table 4: Mass Timber Panel Support at Mass Timber Wall Panel

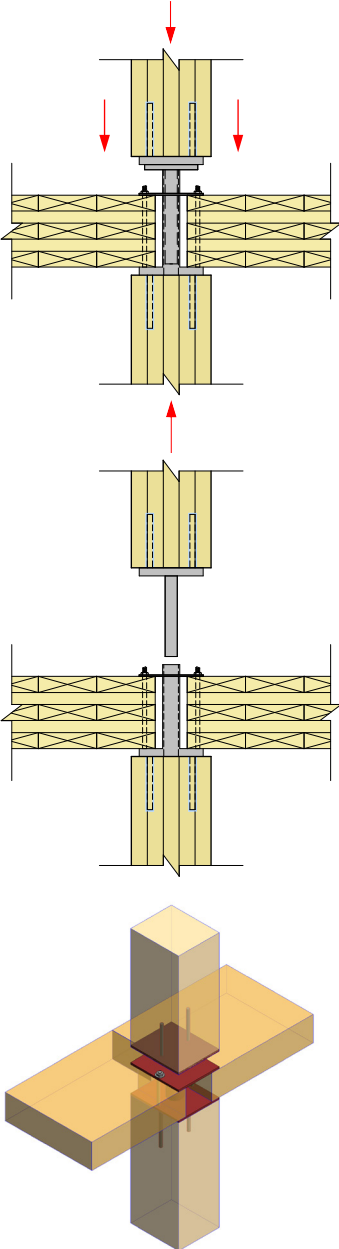
Connection Type	Image	Designer Notes	Class	Load	Cost	Const	Inspect	Fire
<p>4-1.</p> <p>Floor Panel Bears on Wall – Platform</p>		<p>Purpose: Transfer of vertical load from floor panel and wall panel above to wall panel below. Can also transfer in-plane and out-of-plane loads between the wall panels and floor panel.</p> <p>Description: Floor panel bears on wall panel below. Wall panel above bears on floor panel. A positive connection is made between panels with partially-threaded screws.</p> <p>Notes:</p> <ul style="list-style-type: none"> • Capacity of primary load path is controlled by perpendicular-to-grain bearing capacity of floor panel. • Screws provide load path for in-plane and out-of-plane loads. • Diagonal screws are used in this connection for positive attachment of upper wall. Care should be taken to not penetrate exterior face of the wall panel. 	1	Medium	\$	Easy	Advanced	Level II
<p>4-2.</p> <p>Roof Panel Bears on Wall – Platform</p>		<p>Purpose: Transfer of vertical load from roof panel to wall panel below. Can also transfer in-plane and out-of-plane loads between the wall panel and roof panel.</p> <p>Description: Roof panel bears on wall panel below. A positive connection is made between panels with partially-threaded screws.</p> <p>Notes:</p> <ul style="list-style-type: none"> • Capacity of primary load path is controlled by perpendicular-to-grain bearing capacity of floor panel or notch. • Reasonable minimum notch bearing width is 1". • Shop machined notch provides more reliable elevation control than applied bracket or ledger. • In panel design, consider that panel is not continuous across connection and multi-span conditions may not be achievable. • Beam must be designed for reduced net section. 	1	Medium	\$	Easy	Easy	Level II

Connection Type	Image	Designer Notes	Class	Load	Cost	Const	Inspect	Fire
<p>4-3.</p> <p>Roof Panel Bears on Wall – Platform with Bracket</p>		<p>Purpose: Transfer of vertical load from roof panel to wall panel below. Can also transfer in-plane and out-of-plane loads between the wall panel and roof panel.</p> <p>Description: Roof panel bears on wall panel below. A positive connection is made between roof and wall panels with custom or proprietary bracket with partially-threaded screws.</p> <p>Notes:</p> <ul style="list-style-type: none"> • Capacity of primary load path is controlled by perpendicular-to-grain bearing capacity of roof panel. • Screws and bracket provide load path for in-plane and out-of-plane loads. • Out-of-plane load carrying capacity is dependent on the stiffness of the bracket and may not be possible. • This connection is used when a greater in-plane load capacity is required when compared to similar Class 1 connections. • Brackets may be proprietary. Potential bracket suppliers include Simpson Strong-Tie, Rothoblaas and MiTek. 	2 or 3	Medium	\$\$	Easy	Easy	Level III
<p>4-4.</p> <p>Roof Panel Bears on Wall – Platform with Brackets</p>		<p>Purpose: Transfer of vertical load from roof panel to wall panel below. Can also transfer in-plane and out-of-plane loads between the wall panel and roof panel.</p> <p>Description: Floor panel bears on wall panel below. Wall panel above bears on floor panel. A positive connection is made between roof and wall panels with custom or proprietary bracket with partially-threaded screws.</p> <p>Notes:</p> <ul style="list-style-type: none"> • Capacity of primary load path is controlled by perpendicular-to-grain bearing capacity of roof panel. • Screws and bracket provide load path for in-plane and out-of-plane loads. • Out-of-plane load carrying capacity is dependent on the stiffness of the bracket and may not be possible. • This connection is used when a greater in-plane load capacity is required when compared to similar Class 1 connections. • Brackets may be proprietary. Potential bracket suppliers include Simpson Strong-Tie, Rothoblaas and MiTek. 	2 or 3	Medium	\$\$	Easy	Easy	Level III

Table 4: Mass Timber Panel Support at Mass Timber Wall Panel

Connection Type	Image	Designer Notes	Class	Load	Cost	Const	Inspect	Fire
4-5. Floor Panel Bears on Wall – Platform with Side Plate		<p>Purpose: Transfer of vertical load from floor panel and wall panel above to wall panel below. Can also transfer in-plane and out-of-plane loads between the wall panels and floor panel.</p> <p>Description: Floor panel bears on wall panel below. Wall panel above bears on floor panel. A positive connection is made between floor panel and walls with side plate with partially-threaded screws.</p> <p>Notes:</p> <ul style="list-style-type: none"> • Capacity of primary load path is controlled by perpendicular-to-grain bearing capacity of floor panel. • Screws and side plate provide load path for in-plane and out-of-plane loads. • Out-of-plane load carrying capacity is dependent on the stiffness of the bracket and may not be possible. • This connection is used when a greater in-plane load capacity is required when compared to similar Class 1 connections. • Installation from exterior of building is required and may be difficult. • Potential side plate suppliers include Rothoblaas. 	2 or 3	Medium	\$\$	Moderate	Easy	Level III
4-6. Floor Panel Bears on Wall – Platform with Concealed Plates		<p>Purpose: Transfer of vertical load from floor panel and wall panel above to wall panel below. Can also transfer in-plane and out-of-plane loads between the wall panels and floor panel.</p> <p>Description: Floor panel bears on wall panel below. Wall panel above bears on floor panel. Concealed connectors with knife plates are first installed on top and bottom of floor panel with partially-threaded screws. Floor panel is installed on wall panel below with positive connection achieved with dowel-type fasteners. Wall panel above is then installed similarly.</p> <p>Notes:</p> <ul style="list-style-type: none"> • Capacity of primary load path is controlled by perpendicular-to-grain bearing capacity of floor panel. • Concealed connectors provide load path for in-plane and out-of-plane loads. • This connection is used when a greater secondary load capacity is required when compared to similar Class 1 connections. 	2	Medium	\$\$\$	Advanced	Advanced	Level II
4-7. Floor Panel Bears on Wall – Platform with Proprietary Connectors		<p>Purpose: Transfer of vertical load from floor panel and wall panel above to wall panel below. Can also transfer in-plane and out-of-plane loads between the wall panels and floor panel.</p> <p>Description: Floor panel bears on wall panel below. Wall panel above bears on floor panel. Proprietary connectors are first installed on top and bottom of floor pane and wall top and base with partially-threaded screws. Shear key connectors on wall and floor panel are aligned and slid into place providing connection. Wall panel above is then installed similarly.</p> <p>Notes:</p> <ul style="list-style-type: none"> • Capacity of primary load path is controlled by perpendicular-to-grain bearing capacity of floor panel. • Connectors may have tight construction tolerance. • Orientation of shear key connectors will determine the construction sequence. • Installation requires alignment of shear key connectors prior to removal of rigging. • Possible suppliers include Rothoblaas, Simpson Strong-tie and Knapp. 	3	Medium	\$\$\$\$	Advanced	Advanced	Level II

Table 4: Mass Timber Panel Support at Mass Timber Wall Panel

Connection Type	Image	Designer Notes	Class	Load	Cost	Const	Inspect	Fire
<p>4-8.</p> <p>Floor Panel Bears on Ledger – Balloon</p>		<p>Purpose: Transfer of vertical load from floor panel to wall panel. Can also transfer in-plane and out-of-plane loads between the wall panel and floor panel.</p> <p>Description: Floor panel bears on wood ledger. A positive connection is made between floor panel and ledger, and ledger and wall with partially-threaded screws.</p> <p>Notes:</p> <ul style="list-style-type: none"> • Capacity of primary load path is controlled by perpendicular-to-grain bearing capacity of floor panel or ledger, or shear capacity of the ledger attachment. • Screws provide load path for in-plane and out-of-plane loads. • Elevation control of ledger is critical. • Diagonal screws can be used in this connection for positive attachment of floor panel. Care should be taken to not penetrate exterior face of the wall panel. • With balloon framing, multi-story walls can be erected rapidly; however, constructability can be affected by the need for temporary bracing of walls. • See <i>Table 14: Mass Timber Wall Panel to Mass Timber Wall Panel</i> for wall panel splice, if any. 	1	Low - medium	\$	Moderate	Easy	Level II
<p>4-9.</p> <p>Floor Panel Bears on Bracket – Balloon</p>		<p>Purpose: Transfer of vertical load from floor panel to wall panel. Can also transfer in-plane and out-of-plane loads between the wall panel and floor panel.</p> <p>Description: Floor panel bears on custom bracket. A positive connection is made between floor panel and bracket, and bracket and wall with partially-threaded screws.</p> <p>Notes:</p> <ul style="list-style-type: none"> • Capacity of primary load path is controlled by perpendicular-to-grain bearing capacity of floor panel, or shear capacity of the bracket fasteners. • Screws and bracket provide load path for in-plane and out-of-plane loads. • Elevation control of bracket is critical. • With balloon framing, multi-story walls can be erected rapidly; however, constructability can be affected by the need for temporary bracing of walls. • See <i>Table 14: Mass Timber Wall Panel to Mass Timber Wall Panel</i> for wall panel splice, if any. 	2	Medium	\$\$	Moderate	Easy - advanced	Level III

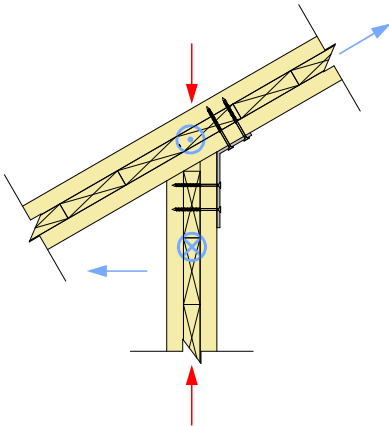
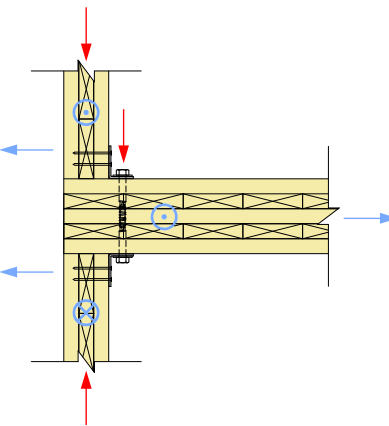
Table 4: Mass Timber Panel Support at Mass Timber Wall Panel

Table 5: Mass Timber Panel Support at Concrete or Masonry

Connection Type	Image	Designer Notes	Class	Load	Cost	Const	Inspect	Fire
5-1. Panel Bears at Top of Wall		<p>Purpose: Transfer of gravity loads from roof or floor panel to wall. Can also transfer in-plane loads between the wall and roof or floor panel.</p> <p>Description: Roof or floor panel bears on the top of wall with pressure-treated wood sill plate or bracket. Positive attachment between panel and sill plate or bracket achieved using partially-threaded screws. Sill plate or bracket is connected to wall with anchor rods or post-installed anchors. Grout below panel provided to accommodate for variation in construction tolerances for different materials and transfer of gravity loads.</p> <p>Notes:</p> <ul style="list-style-type: none"> • Capacity of primary load path is controlled by perpendicular-to-grain bearing capacity of panel. • Bracket provides accommodation for variation in top of wall elevation. Grout is installed after panel installation. • Grout shown between top of wall and bottom of panel in lower detail may be omitted if load carrying capacity of angle connection alone is sufficient. • Bracket may be attached to wall using welded embed instead of post-installed anchor. 	2	High	\$\$	Easy	Easy	Level II - Level III
5-2. Panel Bears at Bracket at Wall		<p>Purpose: Transfer of gravity loads from roof or floor panel to wall. Can also transfer in-plane loads between the wall and roof or floor panel.</p> <p>Description: Panel bears on custom-fabricated connector with positive attachment between panel and connector using partially-threaded screws. Steel connector is attached to wall with post-installed anchors or embeds.</p> <p>Notes:</p> <ul style="list-style-type: none"> • Capacity of connection is dependent on perpendicular-to-grain capacity of panel and shear and tensile capacity of wall connector. • Consider eccentricity of panel bearing on connector. • Connection should accommodate different expected tolerance between concrete construction and timber construction. • Connection may be required to transfer out-of-plane wall loads into diaphragm. • Bracket may be added to top of panel where additional in-plane load transfer is required. • Inspectability is difficult if lower bracket is upturned at panel edge. 	2	Low - medium	\$\$	Moderate	Easy	Level III

Connection Type	Image	Designer Notes	Class	Load	Cost	Const	Inspect	Fire
5-3. Panel Bears on Ledger at Wall		<p>Purpose: Transfer of vertical loads from roof or floor panel to wall. Can also transfer in-plane loads between the wall and roof or floor panel.</p> <p>Description: Panel bears on wood ledger and is connected with partially-threaded screws. Ledger is attached to wall with post-installed anchors.</p> <p>Notes:</p> <ul style="list-style-type: none"> • Capacity of connection is dependent on capacity of anchor securing ledger to wall through dowel bearing. • Screws provide load path for in-plane loads. • Elevation control of ledger is critical. 	2	High	\$\$	Easy	Easy	Level II - Level III
5-4. Panel Bears at Bracket at Wall with Collector Plate		<p>Purpose: Transfer of diaphragm forces from roof or floor panel to vertical lateral force-resisting system.</p> <p>Description: Steel collector plate is connected to top of roof or floor panel with partially-threaded screws. Steel collector plate is welded to embed.</p> <p>Notes:</p> <ul style="list-style-type: none"> • Capacity of connection in the mass timber components is dependent on the screwed connection between the collector plate and panel or diaphragm capacity of the panel. • A bolted connection to the embed may be preferred to avoid complications associated with welding adjacent to mass timber panels. • Refer to other details in this table for gravity load transfer along length of panel to concrete connection. 	2	Low - medium	\$\$	Moderate	Easy	Level III

Table 5: Mass Timber Panel Support at Concrete or Masonry

Connection Type	Image	Designer Notes	Class	Load	Cost	Const	Inspect	Fire
5-5. Panel is Supported by Proprietary Connector (Simpson Holdown Detail)		<p>Purpose: Transfer of diaphragm forces from roof or floor panel to vertical lateral force-resisting system.</p> <p>Description: Proprietary connector is connected to top of roof or floor panel with partially-threaded screws.</p> <p>Notes:</p> <ul style="list-style-type: none"> • Capacity of connection in the mass timber components is dependent on manufacturer’s literature. • Refer to other details in this table for gravity load transfer along length of panel to concrete connection. 	3	Medium	\$\$	Easy	Easy	Level III

Table 5: Mass Timber Panel Support at Concrete or Masonry

Table 6: Mass Timber Panel Support at Light Frame

Connection Type	Image	Designer Notes	Class	Load	Cost	Const	Inspect	Fire
<p>6-1.</p> <p>Roof Panel Bears on top of Wall</p>		<p>Purpose: Transfer of vertical load from roof panel to wall below. Can also transfer in-plane and out-of-plane loads between the wall and roof panel.</p> <p>Description: Roof panels bear on wall below. A positive connection is made between the roof panel and wall with partially-threaded screws.</p> <p>Notes:</p> <ul style="list-style-type: none"> • Capacity of primary load path is controlled by perpendicular-to-grain bearing capacity of roof panel or wood stud wall. • Screws provide load path for in-plane and out-of-plane loads. 	1	High	\$	Easy	Easy	Level II

Connection Type	Image	Designer Notes	Class	Load	Cost	Const	Inspect	Fire
6-2. Floor Panel Bears on Wall – Platform with Non-Fire-Resistance-Rated Walls		<p>Purpose: Transfer of vertical load from floor panel and wall above to wall below. Can also transfer in-plane and out-of-plane loads between the wall and floor panel.</p> <p>Description: Floor panel bears on wall below. Wall above bears on floor panel. A positive connection is made between walls and floor panel with dowel-type fasteners.</p> <p>Notes:</p> <ul style="list-style-type: none"> • Capacity of primary load path is controlled by perpendicular-to-grain bearing capacity of floor panel or wood stud walls. • Dowel-type fasteners provide load path for in-plane and out-of-plane loads. • Because the wood-framed walls are not rated for fire resistance, there is no need to rate the connection for fire resistance. 	1	High	\$	Easy	Easy	n/a
6-3. Floor Panel Bears on Wall – Platform with Fire Retardant-Treated Walls		<p>Purpose: Transfer of vertical load from floor panel and wall above to wall below. Can also transfer in-plane and out-of-plane loads between the wall and floor panel.</p> <p>Description: Floor panel bears on wall below. Wood rim installed on outside face of panel. (FRT may be required by the AHJ; refer to AWC DCA3). Wall above bears on rim and floor panel. A positive connection is made between walls, rim and floor panel with partially-threaded screws.</p> <p>Notes:</p> <ul style="list-style-type: none"> • Capacity of primary load path is controlled by perpendicular-to-grain bearing capacity of floor panel or wood stud walls. • Screws provide load path for in-plane and out-of-plane loads. • Wood wall studs, plates and sheathing must be fire retardant-treated to receive fire-resistance rating. • Gravity loads from wall above are transferred through rim to wall below. 	1	Medium	\$\$	Easy	Easy	Level II

Table 6: Mass Timber Panel Support at Light Frame

Connection Type	Image	Designer Notes	Class	Load	Cost	Const	Inspect	Fire
<p>6-4.</p> <p>Floor Panel Bears on Ledger – Balloon</p>		<p>Purpose: Transfer of vertical load from floor panel to wall. Can also transfer in-plane and out-of-plane loads between the wall and floor panel.</p> <p>Description: Floor panel bears on wood ledger. A positive connection is made between panel and ledger, and ledger and wall with partially-threaded screws. A proprietary clip between wall stud and panel is made using dowel-type fasteners. Blocking is fastened with dowel-type fasteners.</p> <p>Notes:</p> <ul style="list-style-type: none"> • Capacity of primary load path is controlled by perpendicular-to-grain bearing capacity of floor panel or ledger, or shear capacity of the ledger attachment. • Screws provide load path for in-plane loads. Proprietary connector and dowel-type fasteners provide load path for out-of-plane loads. • Blocking is provided for fire blocking between floors and for transfer of shear forces out of the diaphragm and into the wall sheathing. • Elevation control of ledger is critical. • With balloon framing, multi-story walls can be erected rapidly; however, constructability can be affected by the need for temporary bracing of walls. 	1	Low	\$\$	Moderate	Easy	Level II

Table 6: Mass Timber Panel Support at Light Frame

Table 7: Mass Timber Panel Support at Steel Beam

Connection Type	Image	Designer Notes	Class	Load	Cost	Const	Inspect	Fire
<p>7-1.</p> <p>Panel Bears on Steel Beam</p>		<p>Purpose: Transfer of vertical load from roof or floor panel to steel beam. Can also transfer shear along the length of the beam.</p> <p>Description: Roof or floor panel bears on top of steel beam. Positive attachment is made with partially-threaded screws.</p> <p>Notes:</p> <ul style="list-style-type: none"> • Capacity of primary load path is controlled by perpendicular-to-grain bearing capacity of floor panel. • Screws provide load path for in-plane loads. • Steel beam flange is pre-drilled to accommodate screws. • Steel beam depth to be great enough for screw installation. 	1	High	\$	Easy	Easy	Level II

Connection Type	Image	Designer Notes	Class	Load	Cost	Const	Inspect	Fire
<p>7-2.</p> <p>Panel Bears on Steel Beam with Angle</p>		<p>Purpose: Transfer of vertical load from roof or floor panel to steel beam. Can also transfer shear along the length of the beam.</p> <p>Description: Roof or floor panel bears on steel angles fastened to web of steel beam, typically with welds or bolts. Positive attachment between angles and panel is made with partially-threaded screws.</p> <p>Notes:</p> <ul style="list-style-type: none"> • Capacity of primary load path is controlled by perpendicular-to-grain bearing capacity of floor panel. • Connection should accommodate different expected tolerance between steel construction and timber construction. • Horizontal leg of angle sized to accommodate screw installation and panel bearing area. • Screws provide load path for in-plane loads. • Consider eccentricity of load on steel beam if panel occurs on one side. • Constructability may depend on connection at opposite end of panel. • Steel beam depth to be great enough for screw installation. • In panel design, consider that panel is not continuous across connection and multi-span conditions may not be achievable. 	2	Medium	\$\$	Advanced	Easy	Level III
<p>7-3.</p> <p>Panel Hung from Beam with Bolts</p>		<p>Purpose: Transfer of vertical load from roof panel to steel beam. Can also transfer shear along the length of the beam.</p> <p>Description: Roof panel attached to bottom flange of steel beam from below and connected with bolts.</p> <p>Notes:</p> <ul style="list-style-type: none"> • Capacity of primary load path is controlled by perpendicular-to-grain bearing capacity of panel on washers. • Bolts provide load path for in-plane loads. • Connection can achieve the appearance of an unsupported panel when viewed from below. Additional work required to conceal fasteners. • Panel cannot be disconnected from rigging until connected to beam, or temporary shoring of panel is required. • Steel beam flange is pre-drilled to accommodate bolts. Bolt holes in panel are field-drilled to accommodate different expected tolerances between steel construction and timber construction. • Consider that top flange of steel beam is unbraced as shown. • Due to the continuous nature of the panels, consider stricter deflection criteria to reduce the likelihood of visible variations in lower panel surface. 	1	Low	\$\$\$	Advanced	Easy	Level III

Table 7: Mass Timber Panel Support at Steel Beam

Connection Type	Image	Designer Notes	Class	Load	Cost	Const	Inspect	Fire
7-4. Panel Bears on Bottom Flange of Steel Beam		<p>Purpose: Transfer of vertical loads from roof or floor panel to steel beam. Can also transfer shear along the length of the beam.</p> <p>Description: Roof or floor panel bears on the bottom flange of the steel beam. Positive attachment is made with partially-threaded screws.</p> <p>Notes:</p> <ul style="list-style-type: none"> • Capacity of primary load path is controlled by perpendicular-to-grain bearing capacity of floor panel or bending capacity of flange. • Increased bearing capacity requires wider or thicker flange. • Screws provide load path for in-plane loads. • Connection should accommodate different expected tolerance between steel construction and timber construction. • Consider eccentricity of load on steel beam if panel occurs on one side. • Constructability may depend on connection at opposite end of panel. • In panel design, consider that panel is not continuous across connection and multi-span conditions may not be achievable. 	1	Medium	\$\$	Advanced	Easy	Level II
7-5. Panel Bears on Proprietary Composite Steel Support		<p>Purpose: Transfer of vertical loads from roof or floor panel to proprietary composite steel support.</p> <p>Description: Roof or floor panel bears on the proprietary steel support member. Attachment of the panels to the support is as specified by the supplier.</p> <p>Notes:</p> <ul style="list-style-type: none"> • Capacity is controlled by perpendicular-to-grain bearing capacity of floor panel. • May also be able to provide shear transfer along the length of the support. Refer to supplier literature for additional information. • Connection should accommodate different expected tolerance between steel construction and timber construction. • In panel design, consider that panel is not continuous across connection and multi-span conditions may not be achievable. • Consider eccentricity of load on steel support if panel occurs on one side. • Consider moisture protection where wood and concrete are in close proximity. • May be fire rated; refer to supplier literature for additional information. • Cost varies greatly depending on particulars of the system chosen. 	3	Medium	\$\$\$-\$\$\$\$	Moderate	Advanced	Level II

Table 7: Mass Timber Panel Support at Steel Beam

Table 8: Mass Timber Beam Support at Mass Timber Girder

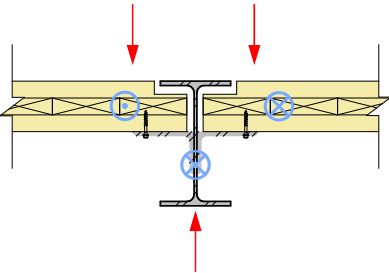
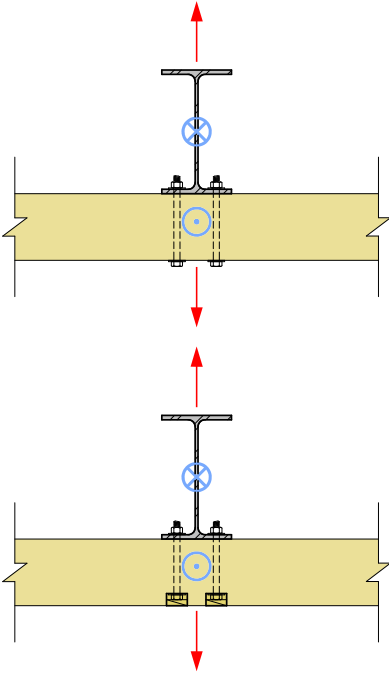
Connection Type	Image	Designer Notes	Class	Load	Cost	Const	Inspect	Fire
<p>8-1.</p> <p>Beam Bears on Girder</p>		<p>Purpose: Transfer of vertical load from wood beam to wood girder.</p> <p>Description: Wood beam bears on top of the wood girder and a positive connection is made with partially-threaded screws that draw the connections tight.</p> <p>Notes:</p> <ul style="list-style-type: none"> • Capacity of primary load path is controlled by perpendicular-to-grain bearing capacity of beam or girder. • It is recommended that screws installed in top surface of beams are slightly overdriven to account for beam shrinkage. • Deck not shown for clarity. Beam may require bracing for lateral-torsional buckling. <p>Other Applications:</p> <ul style="list-style-type: none"> • <i>Table 9: Mass Timber Beam Support at Mass Timber Column</i> • <i>Table 10: Mass Timber Beam Support at Mass Timber Wall Panel</i> 	1	High	\$	Easy	Easy	Level II
<p>8-2.</p> <p>Beam Bears in Girder with Notch</p>		<p>Purpose: Transfer of vertical load from wood beam to wood girder.</p> <p>Description: Wood beam bears in a notch in the wood girder and a positive connection is made with partially-threaded screws that draw the connections tight.</p> <p>Notes:</p> <ul style="list-style-type: none"> • It is preferable for the notch depth to match the beam depth so that beam does not need to be notched as well. • Bearing width is controlled by perpendicular-to-grain bearing. Reasonable minimum bearing width of 1". • See the 2018 NDS and <i>AITC Technical Note 19 Guidelines for Evaluation of Holes and Notches in Structural Glued Laminated Timber Beams</i> for notch sizing. A deep notch methodology is provided in MTC Solutions' <i>ASSY Screws as Tensile Reinforcement in Notched Beams</i>. • Fully-threaded screws may be used to resist possible shear failure (splitting along the grain) that would propagate from a stress concentration at the notch. This is outside the scope of the NDS and should only be done with careful consideration. See MTC Solutions' <i>Full Thread SWG ASSY Screws in Reinforcement</i> for guidance. • Deck not shown for clarity. Beam may require bracing for lateral-torsional buckling. <p>Other Applications:</p> <ul style="list-style-type: none"> • <i>Table 9: Mass Timber Beam Support at Mass Timber Column</i> • <i>Table 10: Mass Timber Beam Support at Mass Timber Wall Panel</i> 	1	Low	\$	Easy	Easy	Level II

Connection Type	Image	Designer Notes	Class	Load	Cost	Const	Inspect	Fire
<p>8-3.</p> <p>Beam Bears Steel Bearing Seat with Knife Plate</p>		<p>Purpose: Transfer of vertical load from wood beam to wood girder.</p> <p>Description: Wood beam is connected to wood girder with a custom-fabricated steel connection consisting of bearing plates for both the beam and girder, and a beam knife plate (shown) or bucket connection to the beam. Beam bears on seat and is connected to steel knife plate with dowel-type fasteners. The connection is fastened to the girder with partially-threaded screws or lag bolts through the bearing plate.</p> <p>Notes:</p> <ul style="list-style-type: none"> • Knife plate instead of bucket connection is more commonly used for exposed connections. • Bearing plate size is dependent on perpendicular-to-grain bearing. • Designer must account for eccentricity between load and reaction. • Dowel connector is for positive connection only. • At top-bearing connections, designer should account for fit of material above. CLT is not typically notched to accommodate connections. • May be desirable to extend bearing plate beyond knife plate to cover kerf in beam for knife plate. • Top-mount connection is shown; face-mount connection is possible. • See the 2018 NDS and <i>AITC Technical Note 19 Guidelines for Evaluation of Holes and Notches in Structural Glued Laminated Timber Beams</i> for notch sizing. • Deck not shown for clarity. Beam may require bracing for lateral-torsional buckling. <p>Other Applications:</p> <ul style="list-style-type: none"> • <i>Table 10: Mass Timber Beam Support at Mass Timber Wall Panel</i>, at top of panel or where bearing notch is provided 	2	High	\$\$	Moderate	Easy	Level III

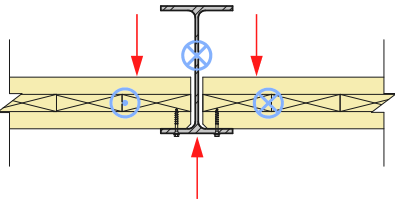
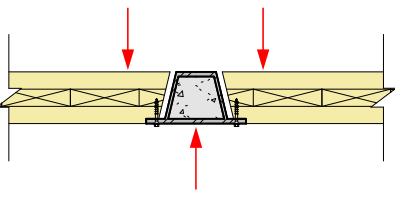
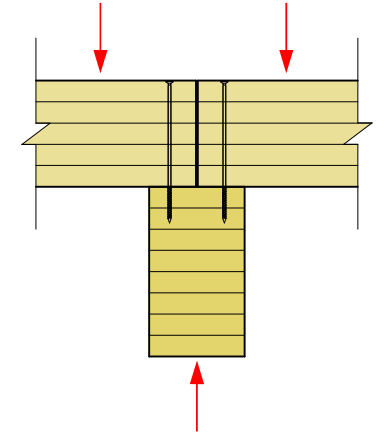
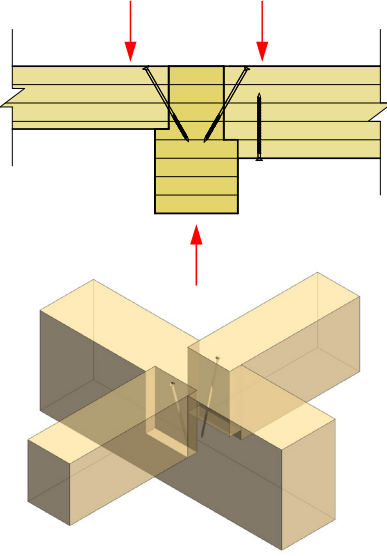
Table 8: Mass Timber Beam Support at Mass Timber Girder

Connection Type	Image	Designer Notes	Class	Load	Cost	Const	Inspect	Fire
8-4. Beam Bears on Concealed Steel Bearing Plate with Knife Plate		<p>Purpose: Transfer of vertical load from wood beam to wood girder.</p> <p>Description: Wood beam is connected to wood girder with a custom-fabricated steel connection consisting of bearing plates for both the beam and girder, and a beam knife plate connected to the beam. Beam bears on seat in slot and is connected to steel knife plate with dowel-type fasteners. The connection is fastened to the girder with partially-threaded screws or lag bolts through the bearing plate.</p> <p>Notes:</p> <ul style="list-style-type: none"> • Bearing plate size is dependent on perpendicular-to-grain bearing. • Method of concealing bearing plate will determine the construction sequence. • Designer must account for eccentricity between load and reaction. • Dowel connector is for positive connection only. • At top-bearing connections, designer should account for fit of material above. CLT is not typically notched to accommodate connections. • Face-mount connection is possible where blocking is used below bearing plate, as shown in lower image. • See the 2018 NDS and AAITC <i>Technical Note 19 Guidelines for Evaluation of Holes and Notches in Structural Glued Laminated Timber Beams</i> for notch sizing. A deep notch methodology is provided in MTC Solutions' <i>ASSY Screws as Tensile Reinforcement in Notched Beams</i>. • Deck not shown for clarity. Beam may require bracing for lateral-torsional buckling. <p>Other Applications:</p> <ul style="list-style-type: none"> • <i>Table 10: Mass Timber Beam Support at Mass Timber Wall Panel</i>, at top of panel or where bearing notch is provided 	2	High	\$\$\$	Advanced	Advanced	Level I
8-5. Beam Bears on Steel Bearing Seat with Side Plates (Bucket)		<p>Purpose: Transfer of vertical load from wood beam to wood girder.</p> <p>Description: Wood beam is connected to wood girder with a custom-fabricated steel connection consisting of a bearing plate and steel side plates (bucket) with dowel-type fasteners into girder. Beam bears on seat and is connected to side plate with dowel-type fasteners.</p> <p>Notes:</p> <ul style="list-style-type: none"> • The capacity of connection is dependent on the screws, lags, and/or bolts in shear and perpendicular-to-grain bearing at the seat. • Face-mount connection is shown; top-mount connection is possible. • The capacity of this connection can be increased by installing screws into girder at an inclined angle. • At dowel connection, designer should account for shrinkage of beam with appropriate dowel location and spacing. See <i>APA EWS T300 Glulam Connection Details Construction Guide</i> for additional information. • Deck not shown for clarity. Beam may require bracing for lateral-torsional buckling. <p>Other Applications:</p> <ul style="list-style-type: none"> • <i>Table 9: Mass Timber Beam Support at Mass Timber Column</i> • <i>Table 10: Mass Timber Beam Support at Mass Timber Wall Panel</i> 	2	Medium	\$\$	Moderate	Easy	Level III

Table 8: Mass Timber Beam Support at Mass Timber Girder

Connection Type	Image	Designer Notes	Class	Load	Cost	Const	Inspect	Fire
8-6. Beam Connected to Girder with Proprietary Hanger		<p>Purpose: Transfer of vertical load from wood beam to wood girder.</p> <p>Description: Wood beam is connected to wood girder with a proprietary hanger.</p> <p>Notes:</p> <ul style="list-style-type: none"> • Face-mount connection shown; top-mount connection possible. • Possible suppliers include Simpson Strong-Tie, Rothoblaas and MiTek. • Deck not shown for clarity. Beam may require bracing for lateral-torsional buckling. 	3	Medium	\$\$-\$\$\$	Easy	Easy	Level III
8-7. Beam Connected to Girder with Concealed Face-Mounted Knife Plate Connector		<p>Purpose: Transfer of vertical load from wood beam to wood girder.</p> <p>Description: Wood beam is connected to wood girder with a concealed, face-mounted plate with a knife plate. Beams bears on dowel-type fasteners in shear.</p> <p>Notes:</p> <ul style="list-style-type: none"> • The capacity of this connection is dependent on the dowel connections to both the beam and the girder. • Connection has tight construction tolerances. • Face-mount connection is shown; top-mount connection is possible. • The knife plate kerf may be visible depending on architectural finishes. • Proprietary options exist; possible manufacturers include Simpson Strong-Tie. • Deck not shown for clarity. Beam may require bracing for lateral-torsional buckling. <p>Other Applications:</p> <ul style="list-style-type: none"> • <i>Table 9: Mass Timber Beam Support at Mass Timber Column</i> • <i>Table 10: Mass Timber Beam Support at Mass Timber Wall Panel</i> 	2 or 3	Medium	\$\$	Moderate	Advanced	Level II
8-8. Beam Connected to Girder with Steel Angles		<p>Purpose: Transfer of vertical load from wood beam to wood girder.</p> <p>Description: Wood beam is connected to wood girder with a steel angle on each side. Beam bears on dowel-type fasteners in shear.</p> <p>Notes:</p> <ul style="list-style-type: none"> • The capacity of this connection is dependent on the dowel connections to both the beam and the girder. • Installation requires beam attachment to girder prior to removal of rigging. • Deck not shown for clarity. Beam may require bracing for lateral-torsional buckling. <p>Other Applications:</p> <ul style="list-style-type: none"> • <i>Table 9: Mass Timber Beam Support at Mass Timber Column</i> • <i>Table 10: Mass Timber Beam Support at Mass Timber Wall Panel</i> 	2	Medium	\$\$	Moderate	Easy	Level III

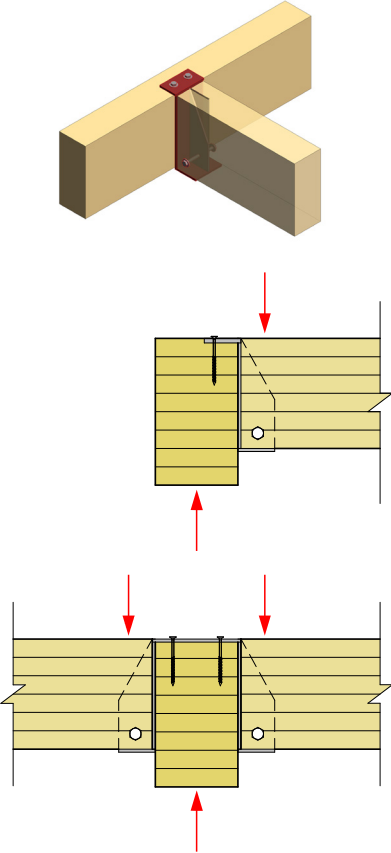
Table 8: Mass Timber Beam Support at Mass Timber Girder

Connection Type	Image	Designer Notes	Class	Load	Cost	Const	Inspect	Fire
8-9. Beam Connected to Girder with Proprietary Concealed Connector		<p>Purpose: Transfer of vertical load from wood beam to wood girder.</p> <p>Description: Wood beam is connected to girder with proprietary connector. Connection from hanger to beam and hanger to girder are as specified by the supplier, generally using screws.</p> <p>Notes:</p> <ul style="list-style-type: none"> • Capacity of the connection is defined by the manufacturer. • This connection type is typically chosen for aesthetics, construction speed and fire rating. See manufacturer for fire rating information. • Fully concealed connection. • Possible to use multiple connectors at single connection for increased capacity. • Connection has tight construction tolerances. • Consider required number of screws relative to member size to control splitting. • Cost increases with reaction. • Manufacturers include Sherpa, Knapp and Rothoblaas. • Deck not shown for clarity. Beam may require bracing for lateral-torsional buckling. <p>Other Applications:</p> <ul style="list-style-type: none"> • <i>Table 9: Mass Timber Beam Support at Mass Timber Column</i> • <i>Table 10: Mass Timber Beam Support at Mass Timber Wall Panel</i> 	3	Low-high	\$\$-\$\$\$\$	Advanced	Advanced	Level I
8-10. Dovetail		<p>Purpose: Transfer of vertical load from wood beam to wood girder.</p> <p>Description: Wood beam is connected to wood girder with a shop-cut wood dovetail connection.</p> <p>Notes:</p> <ul style="list-style-type: none"> • Capacity of connection determined for perpendicular-to-grain bearing and wood shear. • Proprietary jig available for fabrication. • Connection has tight construction tolerances. • Possible jig suppliers include Lignatool. • Deck not shown for clarity. Beam may require bracing for lateral-torsional buckling. 	1 or 3	Low	\$\$-\$\$\$	Advanced	Advanced	Level II

Table 8: Mass Timber Beam Support at Mass Timber Girder

Connection Type	Image	Designer Notes	Class	Load	Cost	Const	Inspect	Fire
8-11. Beam Splice with Steel Plate Scarf Joint		<p>Purpose: Transfer of vertical load from one wood beam end to a second beam in line with the first.</p> <p>Description: Wood beam is connected to a supported wood beam with a top-mounted steel connector.</p> <p>Notes:</p> <ul style="list-style-type: none"> • Load is transferred through perpendicular to grain bearing. • Proprietary options exist. Possible suppliers include Simpson Strong-Tie. • Deck not shown for clarity. Beam may require bracing for lateral-torsional buckling. 	2 or 3	Medium	\$\$	Easy	Easy	Level III

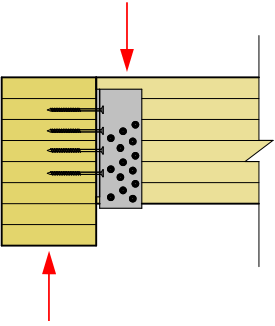
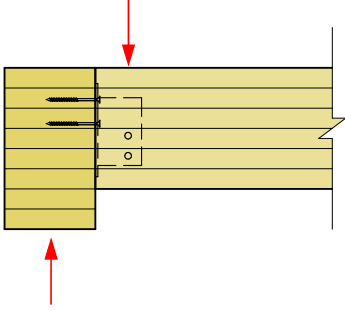
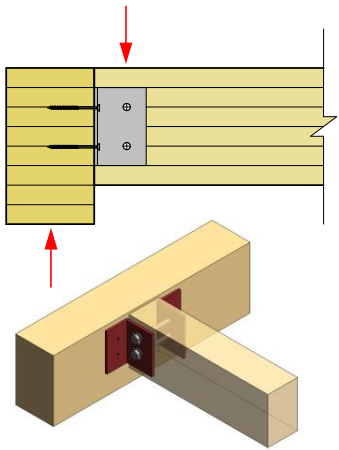
Table 8: Mass Timber Beam Support at Mass Timber Girder

Table 9: Mass Timber Beam Support at Mass Timber Column

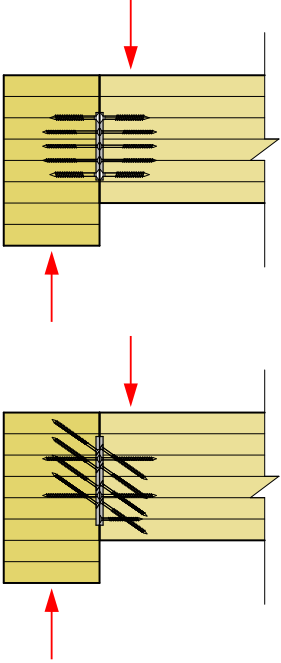
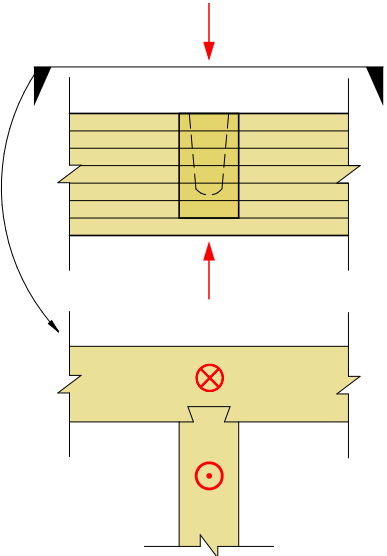
Connection Type	Image	Designer Notes	Class	Load	Cost	Const	Inspect	Fire
<p>9-1.</p> <p>Beam Bears on Column</p>		<p>Purpose: Transfer of vertical load from beam to column.</p> <p>Description: Beam bears on top of column. Beam is connected to top of column with partially-threaded screws.</p> <p>Notes:</p> <ul style="list-style-type: none"> • Capacity of connection is dependent on perpendicular-to-grain capacity of the beam. • It is recommended that screws installed in beam are slightly overdriven to account for beam shrinkage. • An erection aid can assist in alignment during installation. • Deck not shown for clarity. Beam may require bracing for lateral-torsional buckling. <p>Other Applications:</p> <ul style="list-style-type: none"> • Beam bears on mass timber wall panel. 	1	High	\$	Easy	Easy	Level II
<p>9-2.</p> <p>Beam Bears on Column with Knife Plate</p>		<p>Purpose: Transfer of vertical load from beam to column.</p> <p>Description: Beam bears on top of column. Beam and column are positively connected to knife plate with dowel-type fasteners.</p> <p>Notes:</p> <ul style="list-style-type: none"> • Capacity of connection is dependent on perpendicular-to-grain capacity of the beam. • Knife plate can be used to transfer uplift loads. • Deck not shown for clarity. Beam may require bracing for lateral-torsional buckling. <p>Other Applications:</p> <ul style="list-style-type: none"> • Beam bears on mass timber wall panel. 	2	High	\$\$	Easy	Advanced	Level II

Connection Type	Image	Designer Notes	Class	Load	Cost	Const	Inspect	Fire
<p>9-3.</p> <p>Beam Bears on Column at Notch</p>		<p>Purpose: Transfer of vertical load from beam to column.</p> <p>Description: Beam bears in a notch at top of column. Beam is connected to top of column with partially-threaded screws.</p> <p>Notes:</p> <ul style="list-style-type: none"> • Capacity of connection is dependent on perpendicular-to-grain capacity of the beam. • Where the connection design requires a tight connection, installation of connectors should draw the connection tight. • Reduced section of column adjacent to notch may be susceptible to damage during shipping and erection. Fully-threaded screws may be used to reinforce the notch. See MTC Solutions' <i>ASSY Screws as Tensile Reinforcement in Notched Beams</i>. • Alignment and tight fit may be difficult to achieve during construction. An erection aid can assist in alignment during installation. • It is recommended to detail the top of the column lower than the top of the beam to account for differential shrinkage between beam and column. • Consider eccentricity of beam bearing on column where necessary. • It is recommended that screws installed in beam and column are slightly overdriven to account for beam shrinkage. • Deck not shown for clarity. Beam may require bracing for lateral-torsional buckling. <p>Other Applications:</p> <ul style="list-style-type: none"> • Beam bears on mass timber wall panel at pocket. 	1	High	\$	Moderate	Easy	Level II
<p>9-4.</p> <p>Multiple Beams Bear on Column Collar</p>		<p>Purpose: Transfer of vertical loads from beams to column.</p> <p>Description: Beams bear on custom fabricated steel column collar. Collar is connected to both the lower column and the column above using screws or dowels.</p> <p>Notes:</p> <ul style="list-style-type: none"> • Connection is commonly seen in historic construction. • Capacity of connection is dependent on perpendicular-to-grain capacity of the beam and parallel-to-grain capacity of the column below. • Connection capacity can be increased by using a larger steel collar. • Refer to the American Wood Council's <i>Heavy Timber Construction</i> guide for additional information • Deck not shown for clarity. Beam may require bracing for lateral-torsional buckling. 	2	High	\$\$\$	Easy	Easy	Level III

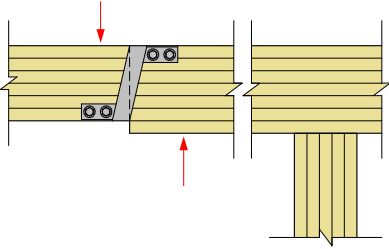
Table 9: Mass Timber Beam Support at Mass Timber Column

Connection Type	Image	Designer Notes	Class	Load	Cost	Const	Inspect	Fire
<p>9-5.</p> <p>Multiple Beams Bear on Column at Notches</p>		<p>Purpose: Transfer of vertical loads from beams to column.</p> <p>Description: The beam bears in notches with or without steel bracket at the top of the column. The beam is connected to the column with partially-threaded screws. Where used, bracket is connected to the column with partially-threaded screws.</p> <p>Notes:</p> <ul style="list-style-type: none"> • Capacity of connection is dependent on perpendicular-to-grain capacity of the beam. • Connection capacity can be increased by increasing the column size to provide adequate bearing capacity. • Connection capacity can be increased by using steel bearing plates at ends of beams. Attachment of plate to column must be designed. • Where the connection design requires a tight connection, installation of connectors should draw the connection tight. • Reduced section of column adjacent to notches may be susceptible to damage during shipping and erection. Fully-threaded screws may be used to reinforce the notch. See MTC Solutions' <i>ASSY Screws as Tensile Reinforcement in Notched Beams</i>. • Alignment and tight fit may be difficult to achieve during construction. An erection aid can assist in alignment during installation. • It is recommended to detail the top of the column lower than the top of the beam to account for differential shrinkage between beam and column. • It is recommended that screws installed in beam are slightly overdriven to account for beam shrinkage. • Fire rating is difficult when steel bracket is used. • Deck not shown for clarity. Beam may require bracing for lateral-torsional buckling. <p>Other applications:</p> <ul style="list-style-type: none"> • Mass timber beam support at face of mass timber wall panel. 	1 or 2	High	\$	Moderate	Easy	Level II - Level III

Table 9: Mass Timber Beam Support at Mass Timber Column

Connection Type	Image	Designer Notes	Class	Load	Cost	Const	Inspect	Fire
<p>9-6.</p> <p>Multiple Beams Bear on Combined Bearing Plate & Beam Hanger</p>		<p>Purpose: Transfer of vertical loads from beams to column or girder.</p> <p>Description: Beams bear on custom-fabricated steel connector that provides bearing onto member below. The member below may be a column or girder. Steel connector is connected to the wood members with screws or dowel connectors.</p> <p>Notes:</p> <ul style="list-style-type: none"> • Connection shows one option only; there are many variations of this connection where beams are supported by a combined custom column cap and beam hanger. • Capacity of connection is dependent on perpendicular-to-grain capacity of beam and parallel-to-grain capacity of the column below. • Column may be present above connection. • Consider differential shrinkage of different elements in this connection. • Deck not shown for clarity. Beam may require bracing for lateral-torsional buckling. <p>Other applications:</p> <ul style="list-style-type: none"> • Mass timber beam support at face of mass timber wall panel. 	2	High	\$\$\$	Moderate	Easy	Level III

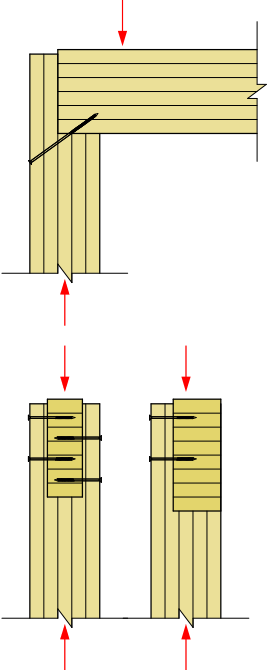
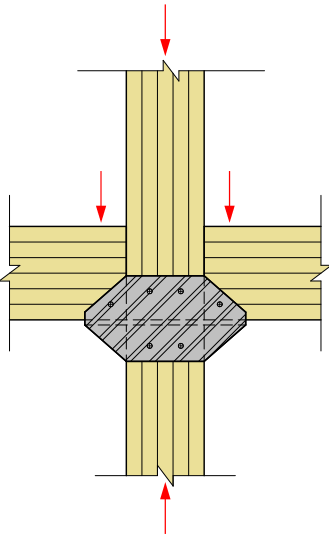
Table 9: Mass Timber Beam Support at Mass Timber Column

Connection Type	Image	Designer Notes	Class	Load	Cost	Const	Inspect	Fire
<p>9-7.</p> <p>Multiple Beams Bear Girders on Notched Column</p>		<p>Purpose: Transfer of vertical load from beams and girders to column.</p> <p>Description: Wood column cross-section is reduced to provide bearing for wood girders. Wood beams bear over wood girders. Positive connection between the beams, girders and column is screws or bolts.</p> <p>Notes:</p> <ul style="list-style-type: none"> • Girders may be simple-span or continuous over column. • Fully-threaded screws reinforce beam notch as necessary. • Capacity is limited by girder perpendicular-to-grain bearing. • Additional screws in the members can provide increased shear capacity. Additional information can be found in MTC Solutions' <i>Full Thread SWG ASSY Screws in Reinforcement</i> paper. • See the 2018 NDS and <i>AITC Technical Note 19 Guidelines for Evaluation of Holes and Notches in Structural Glued Laminated Timber Beams</i> for notch sizing. A deep notch methodology is provided in MTC Solutions' <i>ASSY Screws as Tensile Reinforcement in Notched Beams</i>. • It is recommended that screws installed in beam are slightly overdriven to account for beam shrinkage. • Deck not shown for clarity. Beam may require bracing for lateral-torsional buckling. 	1	High	\$\$	Advanced	Advanced	Level II
<p>9-8.</p> <p>Multiple Beams Bear on Bearing Plate with Steel Standoff Supporting Column Above</p>		<p>Purpose: Transfer of vertical loads from beams to column and transfer of vertical load from column above directly to column below.</p> <p>Description: Column above floor is supported by steel standoff and beams bear on plate with a knife plate at base of standoff. Steel components are connected to wood with glued-in rods, dowels, or screws.</p> <p>Notes:</p> <ul style="list-style-type: none"> • Alternate connections include bucket plates for columns and/or beams with through-bolts. • Beams may also be framed in perpendicular direction. • Capacity of connection is dependent on perpendicular-to-grain capacity of beam and parallel-to-grain capacity of the columns. • Deck not shown for clarity. Beam may require bracing for lateral-torsional buckling. 	2	High	\$\$\$	Moderate	Advanced	Level III

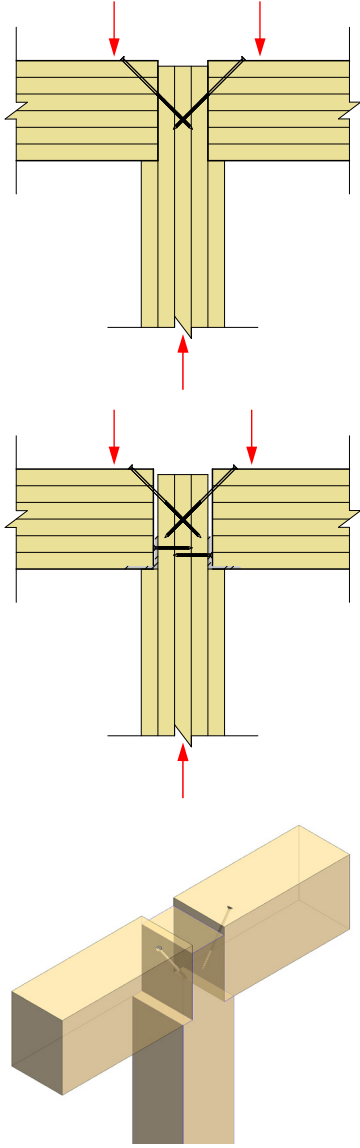
Table 9: Mass Timber Beam Support at Mass Timber Column

Connection Type	Image	Designer Notes	Class	Load	Cost	Const	Inspect	Fire
<p>9-9.</p> <p>Multiple Beams Bear on Girders on Bearing Plate with Steel Standoff Supporting Column Above</p>		<p>Purpose: Transfer of vertical load from beams and girders to column. Connection accommodates column above.</p> <p>Description: Columns are separated by a custom steel standoff with bearing plates, beams bear on girder, and girder bears on lower column bearing plate. Positive connections between the beams and girders vary. Bearing plates are attached to columns with screws or threaded rods with adhesive.</p> <p>Notes:</p> <ul style="list-style-type: none"> • Alternate connections for columns include bucket plates with through-bolts. • Alternate connections for beams include knife plates, which also provide capacity for drag element. • Girders may be simple-span or continuous over column. • Capacity is limited by girder perpendicular-to-grain bearing. • Additional screws in the members can provide increased shear capacity. Additional information can be found in MTC Solutions' <i>Full Thread SWG ASSY Screws in Reinforcement</i>. • See the 2018 NDS and American Institute of Timber Construction's <i>AITC Technical Note 19 Guidelines for Evaluation of Holes and Notches in Structural Glued Laminated Timber Beams</i> for notch sizing. A deep notch methodology is provided in MTC Solutions <i>ASSY Screws as Tensile Reinforcement in Notched Beams</i>. • It is recommended that screws installed in beam are slightly overdriven to account for beam shrinkage. • Deck not shown for clarity. Beam may require bracing for lateral-torsional buckling. 	2	High	\$\$\$	Advanced	Advanced	Level III

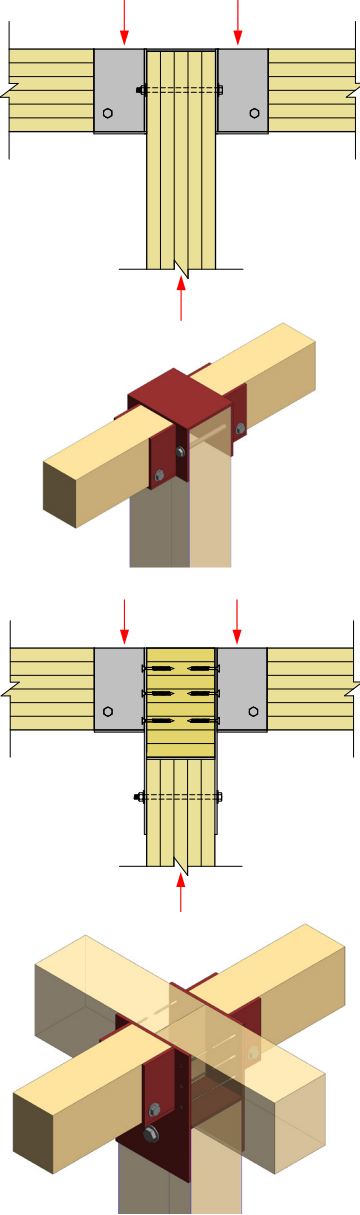
Table 9: Mass Timber Beam Support at Mass Timber Column

Connection Type	Image	Designer Notes	Class	Load	Cost	Const	Inspect	Fire
9-10. Column and Beam Bear on Column at Standoff		<p>Purpose: Transfer of vertical load from beam and column above to column below.</p> <p>Description: Mass timber beam with fabricated hole for standoff bears on column below. Column above bears on custom-fabricated steel connection. Custom standoff consists of upper bearing plate welded to an alignment guide and a lower bearing plate welded to a standoff. Upper and lower bearing plates are fastened to columns with epoxied threaded rods or partially-threaded screws. Alignment guide is fastened to standoff with dowel-type fasteners.</p> <p>Notes:</p> <ul style="list-style-type: none"> Capacity of connection is dependent on perpendicular-to-grain bearing capacity of beam at bearing plate or parallel-to-grain bearing capacity of column at bearing plate. Constructability can be affected by the need for temporary bracing of column. Steel connection assembly pieces are pre-installed on columns. Deck not shown for clarity. Beam may require bracing for lateral-torsional buckling. 	2	Medium	\$\$\$	Advanced	Advanced	Level II
9-11. Beam Bears on Steel Bearing Seat with Knife Plates on Column		<p>Purpose: Transfer of vertical load from beam to column.</p> <p>Description: Mass timber beam is connected to mass timber column with a custom-fabricated steel connection consisting of bearing plates for both the beam and column. Knife plates are provided in the steel connection at both bearing plates. Beam bears on bearing plate and is positively connected to steel knife plate with dowel-type fasteners. Connector bears on column with stiffened plate and is fastened with partially-threaded screws.</p> <p>Notes:</p> <ul style="list-style-type: none"> Capacity of connection is dependent on perpendicular-to-grain bearing capacity of beam at bearing plate. Designer must account for eccentricity between load and reaction. Designer should account for fit of material above. CLT is not typically notched to accommodate connections. May be desirable to extend bearing plate beyond knife plate to cover kerf in beam for knife plate. See <i>Table 8 (8-4): Beam Bears on Concealed Steel Bearing Plate with Knife Plate</i> for method of fire rating this connection. Deck not shown for clarity. Beam may require bracing for lateral-torsional buckling. 	2	Medium	\$\$	Moderate	Advanced	Level III

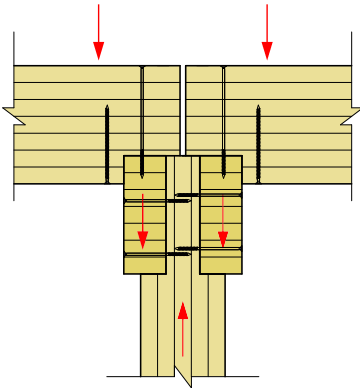
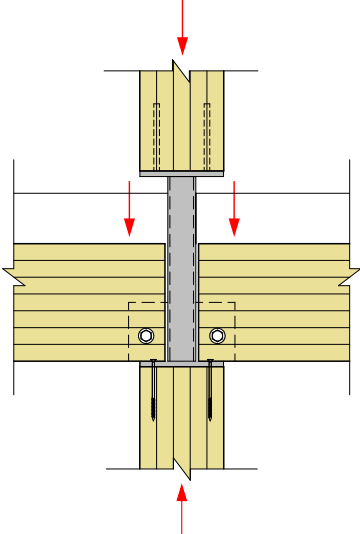
For additional Mass Timber Beam Support at Mass Timber Column connections, see *Table 9: Mass Timber Beam Support at Mass Timber Column* with other applications noted in the Designer Notes section.

Table 10: Mass Timber Beam Support at Mass Timber Wall Panel

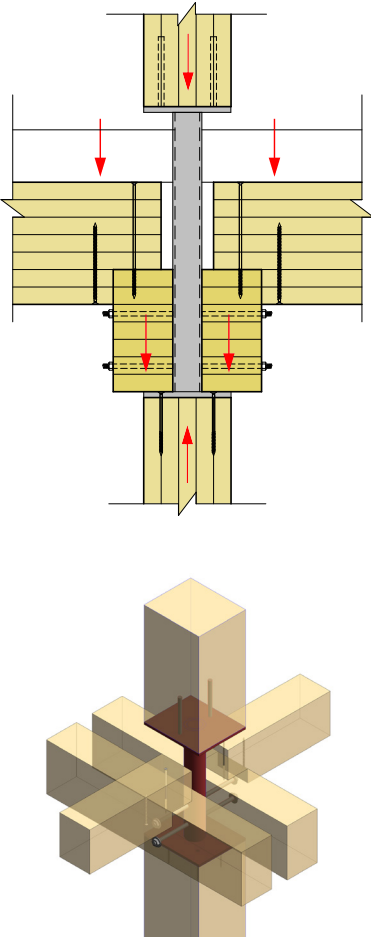
Connection Type	Image	Designer Notes	Class	Load	Cost	Const	Inspect	Fire
10-1. Beam Bears on Mass Timber Wall Panel		<p>Purpose: Transfer of vertical load from beam to mass timber wall panel.</p> <p>Description: Beam bears on top of mass timber wall panel. Beam is connected to top of wall panel with partially-threaded screws.</p> <p>Notes:</p> <ul style="list-style-type: none"> • Capacity of connection is dependent on perpendicular-to-grain capacity of the beam. • Screws provide load path for in-plane and out-of-plane loads. • Clip can be used to connect beam to top of wall panel. Clip can be custom fabricated or proprietary. Inclusion of clip changes connection class, increases cost and makes fire rating difficult. Potential suppliers include Simpson Strong-Tie and Rothoblaas. • Deck not shown for clarity. Beam may require bracing for lateral-torsional buckling. 	1, 2 or 3	High	\$-\$\$	Moderate	Easy	Level II
10-2. Beam Bears on Mass Timber Wall Panel at Pocket		<p>Purpose: Transfer of vertical load from beam to mass timber wall panel. Can also transfer out-of-plane loads from the wall panel to the beam.</p> <p>Description: Beam bears on mass timber wall panel at pocket in wall. Beam is connected to wall panel with partially-threaded screws.</p> <p>Notes:</p> <ul style="list-style-type: none"> • Capacity of connection is dependent on perpendicular-to-grain capacity of the beam. • Screws and bracket provide load path for in-plane and out-of-plane loads. • Screws can be installed diagonally from wall panel into beam (shown) or vertically from top of beam into wall panel. • Deck not shown for clarity. Beam may require bracing for lateral-torsional buckling. 	1	High	\$	Moderate	Easy	Level II

For additional connections, see *Table 8: Mass Timber Beam at Mass Timber Girder* and *Table 9: Mass Timber Beam at Mass Timber Column*.

Table 11: Mass Timber Beam Support at Concrete or Masonry

Connection Type	Image	Designer Notes	Class	Load	Cost	Const	Inspect	Fire
<p>11-1.</p> <p>Beam Perpendicular to Wall Connected to Face of Wall</p>		<p>Purpose: Transfer of vertical load from beam to wall.</p> <p>Description: Beam bears on steel bucket or angle with knife plate. Beam is attached to bucket or knife plate with dowel-type fasteners. Steel connector is attached to wall with post-installed anchors or embed.</p> <p>Notes:</p> <ul style="list-style-type: none"> • Capacity of connection is dependent on perpendicular-to-grain capacity of beam and shear and tensile capacity of concrete connector. • Consider eccentricity of beam bearing on connector. • Connection should accommodate different expected tolerance between concrete construction and timber construction. • May be desirable to extend bearing plate beyond knife plate to cover kerf in beam for knife plate. • Proprietary options exist. Potential suppliers include Simpson Strong-Tie. • Deck not shown for clarity. Beam may require bracing for lateral-torsional buckling. 	2 or 3	Medium	\$\$	Moderate	Easy	Level III
<p>11-2.</p> <p>Beam Perpendicular to Wall Connected to Face of Wall with Top Bearing</p>		<p>Purpose: Transfer of vertical loads from beam to wall.</p> <p>Description: Beam bears on custom-fabricated connector with steel bucket. Positive attachment between beam and steel connector achieved using dowel-type fasteners. Top plate of connector bears on pocket in wall. Pocket is filled with grout. Anchors from steel plate to wall are utilized for positive attachment and to resist eccentricity in the connection.</p> <p>Notes:</p> <ul style="list-style-type: none"> • Capacity of connection is dependent on perpendicular-to-grain capacity of beam. • Consider eccentricity of beam bearing on seat. • Consider edge distances for wall anchors below the slot in the wall. • Connection may also be utilized at the top of a wall. • May be desirable to extend bearing plate beyond knife plate to cover kerf in beam for knife plate. • Bottom of beam can be notched to align with bottom of steel bearing seat if desired. • Connection should accommodate different expected tolerance between concrete construction and timber construction. • Deck not shown for clarity. Beam may require bracing for lateral-torsional buckling. 	2	High	\$\$	Advanced	Advanced	Level III

Table 11: Mass Timber Beam Support at Concrete or Masonry

Connection Type	Image	Designer Notes	Class	Load	Cost	Const	Inspect	Fire
11-3. Beam Bears at Top of Column or Wall		<p>Purpose: Transfer of vertical load from beam to top of column or wall.</p> <p>Description: Beam bears on top of concrete or CMU column or wall. Beam is connected to column using bearing plate with knife plate or proprietary connector. Bearing plate is connection to concrete or CMU with cast-in anchor rods or post-installed anchors. Grout below bearing plate provided to accommodate for variation in construction tolerances for different materials.</p> <p>Notes:</p> <ul style="list-style-type: none"> Capacity of connection is dependent on perpendicular-to-grain capacity of beam. Proprietary connectors embedded in concrete may be used to support beam. Embedded connectors may have lower construction tolerance. Potential suppliers include Simpson Strong-Tie. Deck not shown for clarity. Beam may require bracing for lateral-torsional buckling. 	2 or 3	High	\$\$	Easy	Easy	Level III
11-4. Beam Parallel to Wall Connected to Face of Wall with Top Bearing		<p>Purpose: Transfer of vertical load from beam to wall.</p> <p>Description: Beam bears on custom fabricated connector with positive attachment between beam and bearing seat using screws. Top plate of connector bears on pocket in wall. Pocket is filled with grout. Anchors from steel plate to wall are utilized for positive attachment and to resist eccentricity in the connection.</p> <p>Notes:</p> <ul style="list-style-type: none"> Capacity of connection is dependent on perpendicular-to-grain capacity of beam. Consider eccentricity of beam bearing on seat. Consider edge distances for wall anchors below the slot in the wall. Connection may also be utilized at the top of a wall. Connection should accommodate different expected tolerance between concrete construction and timber construction. Deck not shown for clarity. Beam may require bracing for lateral-torsional buckling. 	2	High	\$\$	Advanced	Advanced	Level III
11-5. Beam Bears on Pilaster		<p>Purpose: Transfer of vertical loads from beam to pilaster.</p> <p>Description: Beam is connected to top of pilaster using a bearing plate with knife or side plates or proprietary connector. Positive attachment between beam and knife or side plates achieved using dowel-type fasteners. Bearing plate is connected to pilaster with anchor rods or post-installed anchors. Grout below bearing plate provided to accommodate for variation in construction tolerances for different materials.</p> <p>Notes:</p> <ul style="list-style-type: none"> Capacity of connection is dependent on perpendicular-to-grain capacity of beam. Proprietary bases embedded in pilaster may be used to support beam. Embedded connectors may have lower construction tolerance. Potential suppliers include Simpson Strong-Tie. Deck not shown for clarity. Beam may require bracing for lateral-torsional buckling. 	2 or 3	High	\$\$	Easy	Easy	Level III

Table 11: Mass Timber Beam Support at Concrete or Masonry

Connection Type	Image	Designer Notes	Class	Load	Cost	Const	Inspect	Fire
11-6. Beam Bears in Wall Pocket		<p>Purpose: Transfer of vertical load from beam to wall.</p> <p>Description: Beam bears in pocket in wall with bearing plate with knife or side plates. Positive attachment between beam and knife or side plates achieved using dowel-type fasteners. Bearing plate is connected to embed plate with threaded studs. Grout between bearing plate and embed plate provided to accommodate for variation in construction tolerances for different materials.</p> <p>Notes:</p> <ul style="list-style-type: none"> • Capacity of connection is dependent on perpendicular to grain capacity of beam. • Consider knife plate and bearing plate attachment with respect to installation sequence when sizing pocket. • At pocket, consider moisture protection where wood and concrete or CMU are in close proximity. • Constructability may depend on connection at opposite end of beam. 	2	High	\$\$	Moderate - advanced	Easy	Level III
11-7. Beam Supported by Knife Plate		<p>Purpose: Transfer of vertical load from beam to wall.</p> <p>Description: Beam is connected to steel knife plate with dowel-type fasteners. Knife plate is connected to embed plate.</p> <p>Notes:</p> <ul style="list-style-type: none"> • Capacity of connection is dependent on fastener shear capacity. • Consider eccentricity of beam loading. • At dowel connection, designer should account for shrinkage of beam with appropriate dowel location and spacing. Refer to <i>APA EWS T300 Glulam Connection Details Construction Guide</i> for additional information. • Knife plate kerf may be full height of beam and will be visible. • Beam cannot be disconnected from rigging until connected to knife plate. 	2	Low	\$\$	Moderate	Easy	Level III

Table 11: Mass Timber Beam Support at Concrete or Masonry

Table 12: Mass Timber Supporting Light Frame Systems

Connection Type	Image	Designer Notes	Class	Load	Cost	Const	Inspect	Fire
12-1. Truss Bears on Wall Panel Pocket – Balloon-Framed		<p>Purpose: Transfer of vertical load from truss to mass timber wall panel below.</p> <p>Description: Truss bears on wall panel at pocket. Truss is positively attached to wall panel with diagonal partially-threaded screws or nails.</p> <p>Notes:</p> <ul style="list-style-type: none"> • Capacity of primary load path is controlled by truss bearing. • Diaphragm connections not shown in detail. Diaphragm and connections to be sized by the designer. • Care should be taken to not penetrate exterior face of the wall panel. 	1	Medium	\$\$	Moderate	Easy	Level II

Connection Type	Image	Designer Notes	Class	Load	Cost	Const	Inspect	Fire
12-2. I-Joist Bears on Hanger – Balloon-Framed		<p>Purpose: Transfer of vertical load from joist to mass timber wall panel.</p> <p>Description: Joist bears on proprietary hanger. Hanger is connected to ledger or wall panel as required by supplier. Where no ledger is provided, blocking occurs between joists as required for in-plane load transfer.</p> <p>Notes:</p> <ul style="list-style-type: none"> • Capacity of primary load path is defined by the manufacturer. • Diaphragm connections not shown in detail. Diaphragm and connections to be sized by the designer. • With balloon framing, multi-story walls can be erected rapidly; however, constructability can be affected by the need for temporary bracing of walls. • Elevation control of hanger or ledger is critical. • Possible suppliers include Simpson Strong-Tie and MiTek. 	3	Medium	\$\$	Moderate	Easy	Level III

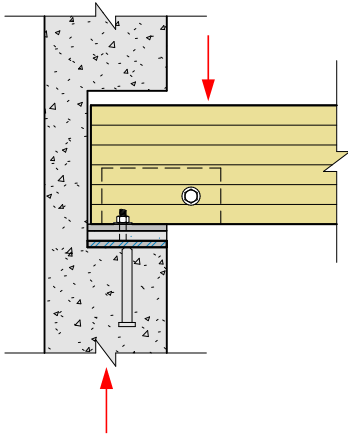
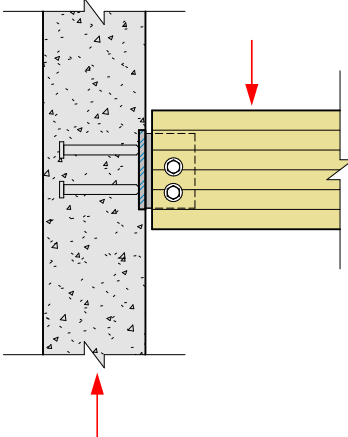
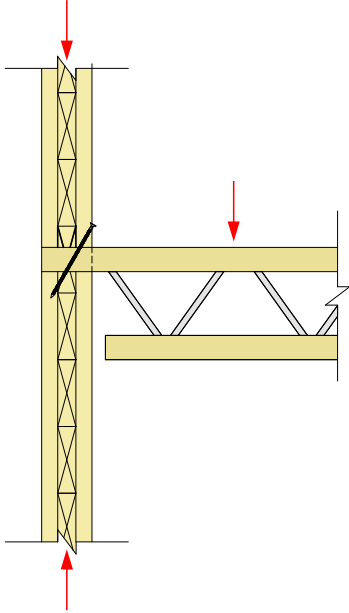
Table 12: Mass Timber Supporting Light Frame Systems

Table 13: Mass Timber Supporting Steel Frame Systems

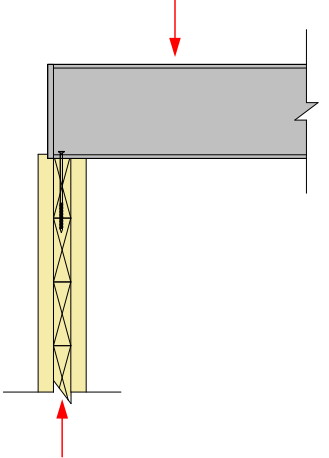
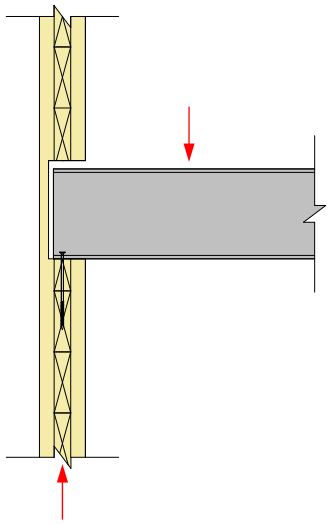
Connection Type	Image	Designer Notes	Class	Load	Cost	Const	Inspect	Fire
<p>13-1.</p> <p>Beam Bears on Mass Timber Panel</p>		<p>Purpose: Transfer of vertical load from steel beam to mass timber wall panel.</p> <p>Description: Beam bears on top of mass timber wall panel and is positively connected to panel with partially-threaded screws.</p> <p>Notes:</p> <ul style="list-style-type: none"> • Capacity of connection is dependent on parallel-to-grain capacity of wall panel. • Increased capacity can be achieved with bearing plate below beam and/or bearing beam on full thickness of wall. • Connection is capable of transferring out-of-plane loads between wall panel and beam where no diaphragm is provided. • Steel beam depth to be great enough for screw installation. Consider alternate attachment where required. • Addition of bearing plate may aid in fastener installation. 	1	High	\$	Easy	Easy	Level II
<p>13-2.</p> <p>Beam Bears on Mass Timber Wall Panel at Pocket</p>		<p>Purpose: Transfer of vertical load from steel beam to mass timber wall panel.</p> <p>Description: Beam bears on mass timber wall panel at pocket in wall. Beam is positively connected to wall with partially-threaded screws.</p> <p>Notes:</p> <ul style="list-style-type: none"> • Capacity of connection is dependent on parallel-to-grain capacity of wall panel. • Increased capacity can be achieved with bearing plate below beam and/or bearing beam on full thickness of wall. • Connection is capable of transferring out-of-plane loads between wall panel and beam where no diaphragm is provided. • Allow adequate clearance in beam pocket for beam installation. • Addition of bearing plate may aid in fastener installation. • Constructability may depend on connection at opposite end of beam. • Constructability may be aided by providing a pocket that extends through the full thickness of the panel. 	1	High	\$	Moderate - advanced	Easy	Level II

Connection Type	Image	Designer Notes	Class	Load	Cost	Const	Inspect	Fire
13-3. Beam Supported by Shear Tab – Balloon-Framed		<p>Purpose: Transfer of vertical load from steel beam to mass timber wall panel.</p> <p>Description: Beam is connected to wall panel with a steel shear tab welded to steel plate. Beam is connected to shear tab with bolts or welds. Plate is connected to face of wall panel using partially-threaded screws.</p> <p>Notes:</p> <ul style="list-style-type: none"> • Capacity of the connection is dependent on the screw connections to the wall panel and the capacity of the beam to shear tab attachment. • Connection is capable of transferring out-of-plane loads between wall panel and beam where no diaphragm is provided. • Wall panel may be routed at steel plate for flush finish. • Consider horizontal slotted holes at shear tab connection for increased constructability and thermal movement. • Elevation control of shear tab is critical. • Constructability may depend on connection at opposite end of beam. • Beam cannot be disconnected from rigging until connected to shear tab. • With balloon framing, multi-story walls can be erected rapidly; however, constructability can be affected by the need for temporary bracing of walls. 	2	Medium	\$\$\$	Moderate	Easy	Level III
13-4. Post Bears on Panel		<p>Purpose: Transfer of vertical load from steel post to mass timber floor or roof panel.</p> <p>Description: Post bears on floor or roof panel with base plate. Base plate is positively connected to mass timber floor panel with dowel-type fasteners.</p> <p>Notes:</p> <ul style="list-style-type: none"> • Capacity of connection is dependent on flexural and rolling shear strength of panel and perpendicular to grain capacity of the panel. • Beam below post increases load carrying capacity. 	2	Low	\$\$	Easy	Easy	Level III

Table 13: Mass Timber Supporting Steel Frame Systems

Connection Type	Image	Designer Notes	Class	Load	Cost	Const	Inspect	Fire
13-5. Beam Bears on Top of Wood Column		<p>Purpose: Transfer of vertical load from steel beam to mass timber column.</p> <p>Description: Beam bears on top of column. Beam is positively connected to column with partially-threaded screws.</p> <p>Notes:</p> <ul style="list-style-type: none"> • Capacity of the connection is dependent on parallel-to-grain capacity of the column. 	1	High	\$	Easy	Easy	Level II
13-6. Beam Bears on Top of Wood Column with Angle		<p>Purpose: Transfer of vertical load from steel beam to mass timber column.</p> <p>Description: Beam is welded to angle with stiffener that knifes into column. Angle bears on column and is positively connected to column with partially-threaded screws.</p> <p>Notes:</p> <ul style="list-style-type: none"> • Capacity of the connection is dependent on parallel-to-grain capacity of the column at angle. • Column may be routed at angle for flush finish. 	2	Medium	\$\$	Easy	Easy	Level III

Table 13: Mass Timber Supporting Steel Frame Systems

Connection Type	Image	Designer Notes	Class	Load	Cost	Const	Inspect	Fire
13-7. Beam Top Flange Bears on Wood Column		<p>Purpose: Transfer of vertical load from steel beam to mass timber column.</p> <p>Description: Beam top flanges bear on top of column. Bottom flanges of beam are coped at column. Beam is positively connected to column with partially-threaded screws.</p> <p>Notes:</p> <ul style="list-style-type: none"> • Capacity of the connection is dependent parallel-to-grain capacity of the column at top flanges. • Column may be routed at top flanges for flush finish. 	1	High	\$\$	Moderate	Easy	Level II

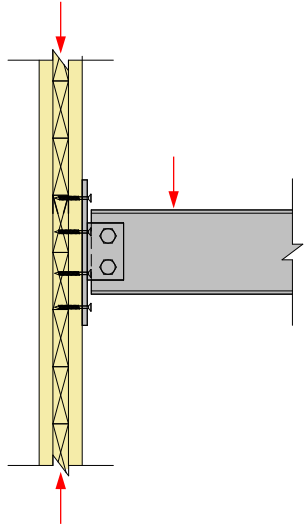
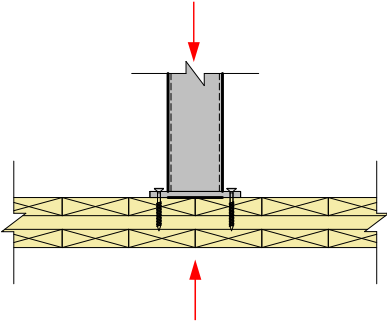
Table 13: Mass Timber Supporting Steel Frame Systems

Table 14: Mass Timber Wall Panel to Mass Timber Wall Panel

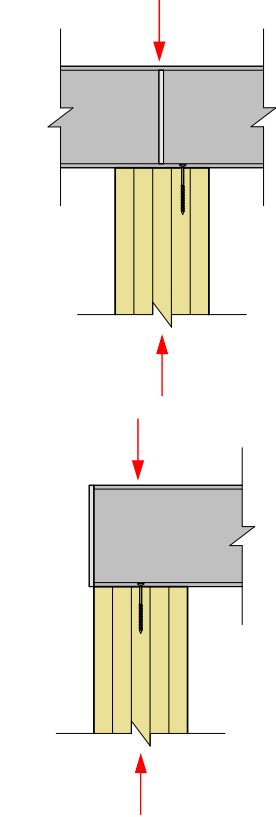
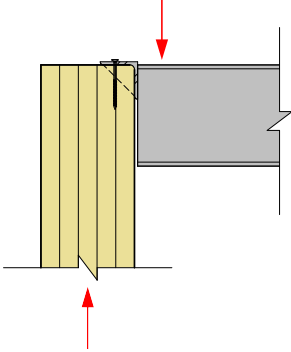
Connection images in this table are shown in plan unless noted otherwise.

Connection Type	Image	Designer Notes	Class	Load	Cost	Const	Inspect	Fire
<p>14-1.</p> <p>Panels Connect with Screws – Perpendicular Intersection</p>		<p>Purpose: Transfer of in-plane and out-of-plane loads between panels. Often used as an erection aid only where connection is not otherwise structurally required.</p> <p>Description: Intersecting panels are butted together and connected with partially-threaded screws..</p> <p>Notes:</p> <ul style="list-style-type: none"> • Capacity of connection is based on capacity of screws. • It is possible to design this connection to enforce kinematic compatibility and thus composite behavior between the two panels. 	1	Low	\$	Easy	Easy	Level II
<p>14-2.</p> <p>Panels Connect with Brackets – Perpendicular Intersection</p>		<p>Purpose: Transfer of in-plane and out-of-plane loads between panels. Often used as an erection aid only where connection is not otherwise structurally required.</p> <p>Description: Intersecting panels are butted together and connected with brackets. Brackets are connected to each panel with dowel-type fasteners.</p> <p>Notes:</p> <ul style="list-style-type: none"> • Capacity of connection is based on capacity of bracket and dowel-type fasteners. • It is possible to design this connection to enforce kinematic compatibility and thus composite behavior between the two panels. • Bracket may be proprietary. Potential bracket suppliers include Simpson Strong-Tie, Rothoblaas and MiTek. 	2 or 3	Medium	\$\$	Easy	Easy	Level III

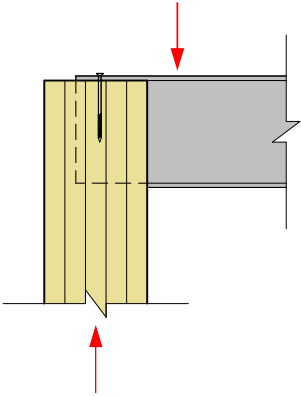
Table 14: Mass Timber Wall Panel to Mass Timber Wall Panel

Connection Type	Image	Designer Notes	Class	Load	Cost	Const	Inspect	Fire
<p>14-3.</p> <p>Panels Connect with Half-Lap Joint – Perpendicular Intersection</p>		<p>Purpose: Transfer of in-plane and out-of-plane loads between panels. Often used as an erection aid only where connection is not otherwise structurally required.</p> <p>Description: Intersecting panels with compatible notches are lapped and connected using partially-threaded screws or nails.</p> <p>Notes:</p> <ul style="list-style-type: none"> • Capacity of connection is controlled by shear capacity of dowel-type fasteners. • Orientation of the notches will determine the construction sequence. • Screws are more common than nails, in particular as panel thickness increases. • Notch width is generally controlled by screw edge distance requirements, which vary by manufacturer. • May be designed to carry lateral loads across joint. Reinforcing screws may be required for this application. • Inconsistencies in notch depth can cause surface variations in adjacent panels. 	1	Low	\$\$	Moderate	Easy	Level I
<p>14-4.</p> <p>Panels Connect with Slot Connector</p>		<p>Purpose: Transfer of in-plane shear along the panel-to-panel joint.</p> <p>Description: Adjacent wall panels are butted together and secured using proprietary slot connector in compatible notches in panels. Slot connectors are positively connected with screws as specified by manufacturer.</p> <p>Notes:</p> <ul style="list-style-type: none"> • Capacity of connection is based on manufacturer specifications. • Connectors have tight construction tolerance. • Possible suppliers include Rothoblaas. 	3	High	\$\$\$	Moderate	Easy	Level III

Table 14: Mass Timber Wall Panel to Mass Timber Wall Panel

Connection Type	Image	Designer Notes	Class	Load	Cost	Const	Inspect	Fire
14-5. Panels Connect with Single Surface Spline		<p>Purpose: Transfer of in-plane shear along the panel-to-panel joint.</p> <p>Description: Adjacent wall panels with routed surfaces are butted together. A plywood spline is fastened to both panels using partially-threaded screws or nails.</p> <p>Notes:</p> <ul style="list-style-type: none"> • Capacity of connection is controlled by shear capacity of dowel-type fasteners. • Double surface spline can be used for increased capacity. • Spline may be fully outside panels without routed surface where wall finishes allow. • Where using nails, consider specifying nail gun nails instead of common wire nails for constructability, or collated screws instead of individual screws. • Where screws are used instead of nails, cost increases and constructability is moderate. • Typical minimum plywood thickness is ½" nominal. • Coordinate spline and rout width and thickness with panel supplier. 	1	Low	\$	Easy	Easy	Level I
14-6. Panels Connect with Double Surface Spline		<p>Purpose: Transfer of in-plane shear along the panel-to-panel joint.</p> <p>Description: Adjacent wall panels with routed surfaces are butted together. A plywood spline is fastened to each side of both panels using partially-threaded screws or nails.</p> <p>Notes:</p> <ul style="list-style-type: none"> • Capacity of connection is controlled by shear capacity of dowel-type fasteners. • Splines may be fully outside panels without routed surface where wall finishes allow. • Where using nails, consider specifying nail gun nails instead of common wire nails for constructability, or collated screws instead of individual screws. • Where screws are used instead of nails, cost increases and constructability is moderate. • Typical minimum plywood thickness is ½" nominal. • Coordinate spline and rout width and thickness with panel supplier. 	1	Medium	\$\$	Easy	Easy	Level II

Table 14: Mass Timber Wall Panel to Mass Timber Wall Panel

Connection Type	Image	Designer Notes	Class	Load	Cost	Const	Inspect	Fire
14-7. Panels Connect with Internal Spline		<p>Purpose: Transfer of in-plane shear along the panel-to-panel joint.</p> <p>Description: Adjacent floor panels with compatible routed channels are butted together. A wood spline is placed in the channel across the joint and fastened with partially-threaded screws or nails.</p> <p>Notes:</p> <ul style="list-style-type: none"> • Capacity of connection is controlled by shear capacity of dowel-type fasteners. • Preferable for conditions that require a hidden connection or where one side of the panel is inaccessible during construction. • Requires extra care during installation as spline is susceptible to damage while placing panels. • Where using nails, consider specifying nail gun nails instead of common wire nails for constructability, or collated screws instead of individual screws. • Increased cost compared to surface splines due to increased construction time. • Typical minimum plywood thickness is ½" nominal. 	1	Low	\$\$	Advanced	Advanced	Level I
14-8. Panels Connect with Half-Lap Joint		<p>Purpose: Transfer of in-plane shear along the panel to panel joint.</p> <p>Description: Adjacent floor panels with compatible notches are lapped and connected using partially-threaded screws or nails.</p> <p>Notes:</p> <ul style="list-style-type: none"> • Capacity of connection is controlled by shear capacity of dowel-type fasteners. • Orientation of the notches will determine the construction sequence. • Screws are more common than nails, in particular as panel thickness increases. • Notch width is generally controlled by screw edge distance requirements, which vary by manufacturer. • May be designed to carry lateral loads across joint. Reinforcing screws may be required for this application. This is outside the scope of the 2018 NDS, and should only be done with careful consideration. • Inconsistencies in notch depth can cause surface variations in adjacent panels. 	1	Low	\$	Moderate	Easy	Level I

Table 14: Mass Timber Wall Panel to Mass Timber Wall Panel

Connection Type	Image	Designer Notes	Class	Load	Cost	Const	Inspect	Fire
14-9. Panels Connect with Screws Across Butt Joint		<p>Purpose: Transfer of in-plane shear along the panel-to-panel joint.</p> <p>Description: Adjacent wall panels are butted together and fastened with fully-threaded diagonal screws.</p> <p>Notes:</p> <ul style="list-style-type: none"> • Capacity of connection is controlled by shear capacity of dowel-type fasteners. • Jig can be used for proper installation of diagonal screws. • Pilot holes can be drilled to aid in screw installation. • Ensure that screws do not extend beyond exposed panel surface. • Fire rating is Level II for CLT panels. 	1	Low	\$\$	Moderate	Advanced	Level I
14-10. Panels Connect with Epoxied Steel Rod – Horizontal Splice		<p>Purpose: Transfer of vertical loads from upper panel to lower panel. Can be used to transfer of out-of-plane loads.</p> <p>Description: Stacking wall panels are butted together and connected with internal steel rods. Steel rods are epoxied in place.</p> <p>Notes:</p> <ul style="list-style-type: none"> • Capacity of connection is controlled by parallel-to-grain bearing strength of panels. • Connectors have tight construction tolerance. 	1	High	\$\$	Moderate	Advanced	Level II
14-11. Panels Connect with Steel Plate – Vertical Splice		<p>Purpose: Transfer of horizontal loads between adjacent panels.</p> <p>Description: Adjacent wall panels are butted together and connected with steel face plate attached with dowel-type fasteners.</p> <p>Notes:</p> <ul style="list-style-type: none"> • Capacity of connection is controlled by shear capacity of dowel-type fasteners and steel plate. 	2 or 3	Medium	\$	Easy	Easy	Level III

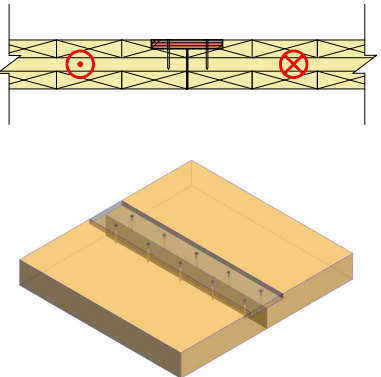
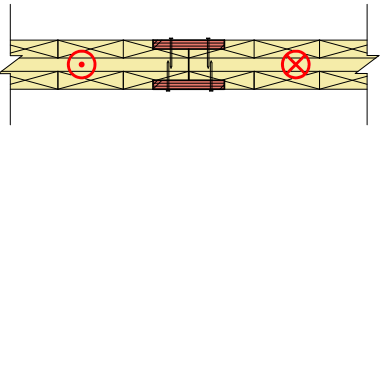
Table 14: Mass Timber Wall Panel to Mass Timber Wall Panel

Table 15: Mass Timber Column Base at Concrete

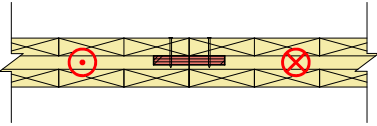
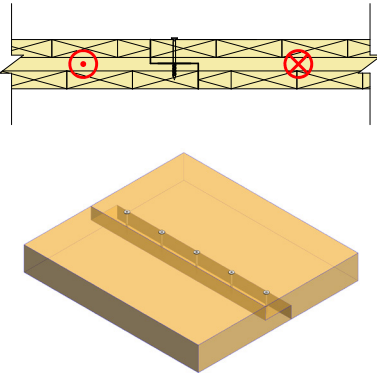
Connection Type	Image	Designer Notes	Class	Load	Cost	Const	Inspect	Fire
<p>15-1.</p> <p>Column Bears with Knife Plate</p>		<p>Purpose: Transfer of vertical load from wood column to concrete.</p> <p>Description: Column bears on custom steel connection consisting of a knife and bearing plate. Knife plate is positively connected to column with dowel-type fasteners. Bearing plate is connected to concrete with post-installed anchors. Grout is provided below bearing plate for elevation control.</p> <p>Notes:</p> <ul style="list-style-type: none"> • Capacity of connection is dependent on parallel-to-grain capacity of the column. • Vertical kerf in column for knife plate may be visible. 	2	High	\$	Easy	Easy	Level III
<p>15-2.</p> <p>Column Bears with Side Plates</p>		<p>Purpose: Transfer of vertical load from wood column to concrete.</p> <p>Description: Column bears on custom steel connection consisting of side and bearing plates. Side plates are positively connected to column with dowel-type fasteners. Bearing plate is connected to concrete with post-installed anchors. Grout is provided below bearing plate for elevation control.</p> <p>Notes:</p> <ul style="list-style-type: none"> • Capacity of connection is dependent on parallel-to-grain capacity of the column. 	2	High	\$	Easy	Easy	Level III

Table 15: Mass Timber Column Base at Concrete

Connection Type	Image	Designer Notes	Class	Load	Cost	Const	Inspect	Fire
<p>15-3.</p> <p>Column Bears with Custom Standoff</p>		<p>Purpose: Transfer of vertical load from wood column to concrete.</p> <p>Description: Column bears on custom steel standoff assembly consisting of upper and lower bearing plates separated by a standoff. Upper bearing plate has knife plate or pipe for connection to column. Column is positively connected to lower bearing plate with dowel-type fasteners. Lower bearing plate is connected to concrete with post-installed anchors. Grout is provided below lower bearing plate for elevation control.</p> <p>Notes:</p> <ul style="list-style-type: none"> • Capacity of connection is dependent on parallel-to-grain capacity of the column. • Consider reducing upper bearing plate dimensions relative to column to accommodate potential column shrinkage. • Standoff allows for architectural finishes and elevates base of column to reduce exposure to potential moisture sources. 	2	High	\$\$	Easy	Easy	Level III

Connection Type	Image	Designer Notes	Class	Load	Cost	Const	Inspect	Fire
15-4. Column Bears with Adjustable Standoff Base		<p>Purpose: Transfer of vertical load from wood column to concrete.</p> <p>Description: Column bears on custom steel standoff assembly consisting of upper bearing assembly and an embed plate separated by a standoff. Upper bearing assembly consists of two steel plates separated by grout and connected with threaded rod for adjustable elevation. Upper bearing assembly is positively connected to column with epoxied rods or partially-threaded screws.</p> <p>Notes:</p> <ul style="list-style-type: none"> • Capacity of connection is dependent on parallel-to-grain capacity of the column bearing on the plate. • Upper bearing plates may be below base of column, so that routing base of column is not required, if aesthetically acceptable. • Standoff allows for architectural finishes and elevates base of column to reduce exposure to potential moisture sources. 	2	High	\$\$\$	Moderate	Advanced	Level III
15-5. Column Bears with Proprietary Dowel Connector		<p>Purpose: Transfer of vertical load from wood column to concrete.</p> <p>Description: Column bears on proprietary base plate. Positive connection to concrete and column is achieved with single post-installed threaded rod.</p> <p>Notes:</p> <ul style="list-style-type: none"> • Capacity of connection is dependent on parallel-to-grain capacity of the column bearing on the plate. • This connection provides reduced elevation control relative to grouted connections. • Potential suppliers include Simpson Strong-Tie. • Additional suppliers provide options for similar connections to the column. Potential suppliers include Timberlinx. 	3	Low	\$	Moderate	Advanced	Level III
15-6. Column Bears with Proprietary Plate Connector		<p>Purpose: Transfer of vertical load from wood column to concrete.</p> <p>Description: Column bears on proprietary steel connector consisting of cruciform knife plate assembly and bearing plate. Knife plates are connected to column with dowel-type fasteners. Bearing plate is connected to concrete with post-installed anchors. Grout is provided below bearing plate for elevation control.</p> <p>Notes:</p> <ul style="list-style-type: none"> • Capacity of connection is as specified by the manufacturer's literature. • Vertical cuts in column for vertical plates may be visible. • Knife plates may be connected to column with adhesive. See manufacturer's literature for additional information. • This connection provides reduced elevation control relative to grouted connections. • Potential suppliers include Rothoblaas. 	3	Medium	\$\$\$	Easy	Easy	Level III

Table 15: Mass Timber Column Base at Concrete

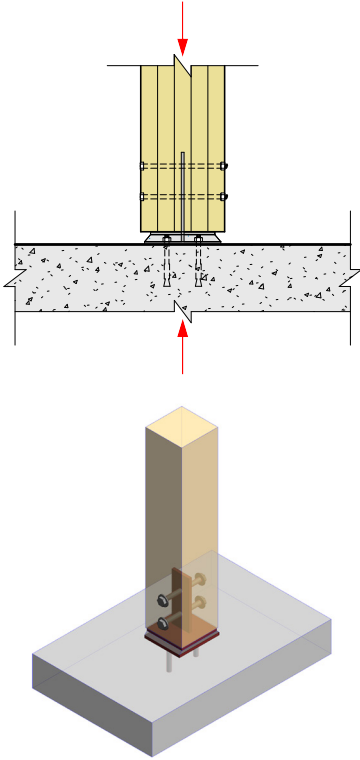
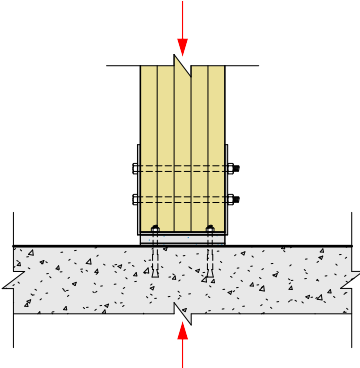
Table 15: Mass Timber Column Base at Concrete

Connection Type	Image	Designer Notes	Class	Load	Cost	Const	Inspect	Fire
<p>15-7.</p> <p>Column Bears with Proprietary Adjustable Column Base</p>		<p>Purpose: Transfer of vertical load from wood column to concrete.</p> <p>Description: Column bears on proprietary steel standoff assembly consisting of upper bearing plate and base plate separated by an adjustable standoff. Upper bearing plate is positively connected to column with partially-threaded screws. Bearing plate is connected to concrete with post-installed anchors.</p> <p>Notes:</p> <ul style="list-style-type: none"> • Capacity of connection is as specified by the manufacturer’s literature. • Adjustable standoff hardware may be concealed by a sleeve. • Height adjustability of column base varies by manufacturer. • Standoff allows for architectural finishes and elevates base of column to reduce exposure to potential moisture sources. • Potential suppliers include Rothoblaas. 	3	Low	\$\$\$\$	Easy	Easy	Level III

Table 16: Mass Timber Wall Panel Base at Concrete

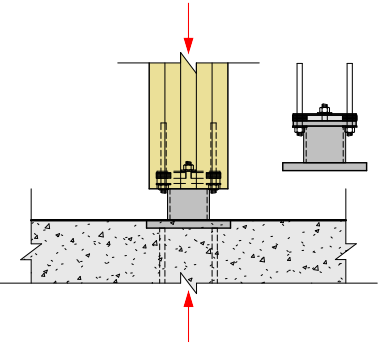
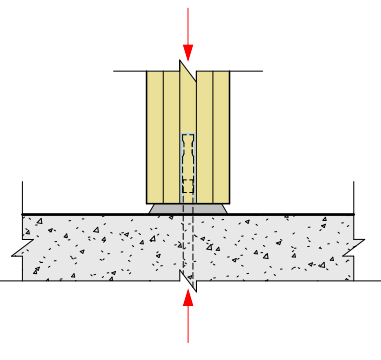
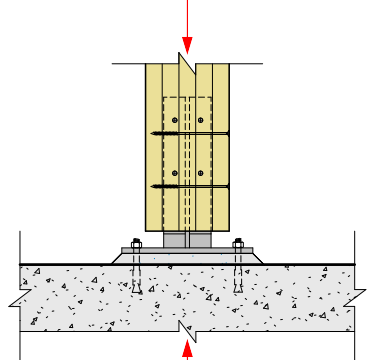
Connection Type	Image	Designer Notes	Class	Load	Cost	Const	Inspect	Fire
16-1. Panel Bears with Sill Plate		<p>Purpose: Transfer of vertical load from panel to concrete.</p> <p>Description: Panel bears on pressure treated sill plate. Plate is connected to panel with toenails and to concrete with cast-in or post-installed anchor bolts. Grout is provided below plate for elevation control.</p> <p>Notes:</p> <ul style="list-style-type: none"> • Capacity of connection is dependent on the perpendicular to grain capacity of plate. • Bracket or side plate may be provided for transfer of in-plane and out-of-plane loads between panel and concrete. • Connection may be installed without grout. Without grout, the connection does not accommodate likely variations in top of concrete elevations, even within the range of appropriate concrete tolerances. 	1	High	\$	Easy	Easy	Level II
16-2. Panel Bears with Sill Plate		<p>Purpose: Transfer of vertical load from panel to concrete. Can also transfer in-plane and out-of-plane loads from the panel to concrete.</p> <p>Description: Panel bears on pressure treated sill plate and is positively connected to concrete using side plate. Side plate is positively connected to panel with partially threaded screws and to concrete with post-installed anchors. Grout is provided below plate for elevation control.</p> <p>Notes:</p> <ul style="list-style-type: none"> • Capacity of connection is dependent on the perpendicular to grain capacity of sill plate or parallel to grain capacity of panel where sill plate is not used. • Screws, anchors, and side plate provide load path for in-plane and out-of-plane loads. • Bracket may be used in conjunction with this connection for increased secondary load transfer capability. • Connection may be installed without grout or plate. Without grout, the connection does not accommodate likely variations in top of concrete elevations, even within the range of appropriate concrete tolerances. Without plate, the panel is more susceptible to moisture wicking and requires added separation material between panel base and concrete. • Proprietary options exist. Potential suppliers include Simpson Strong-Tie, Rothoblaas and MiTek. 	2 or 3	High	\$\$	Easy	Easy	Level III

Connection Type	Image	Designer Notes	Class	Load	Cost	Const	Inspect	Fire
<p>16-3.</p> <p>Panel Bears with Bracket</p>		<p>Purpose: Transfer of vertical load from panel to concrete. Can also transfer in-plane and out-of-plane loads from the panel to concrete.</p> <p>Description: Panel bears on pressure-treated sill plate and is positively connected to concrete using bracket. Bracket is positively connected to panel with partially-threaded screws and to concrete with post-installed anchors. Grout is provided below plate for elevation control.</p> <p>Notes:</p> <ul style="list-style-type: none"> • Capacity of connection is dependent on the perpendicular-to-grain capacity of sill plate or parallel-to-grain capacity of panel where sill plate is not used. • Screws, anchors, and bracket provide load path for in-plane and out-of-plane loads. • Side plate may be used in conjunction with this connection for increased secondary load transfer capability. • Connection may be installed without grout or plate. Without grout, the connection does not accommodate likely variations in top of concrete elevations, even within the range of appropriate concrete tolerances. Without plate, the panel is more susceptible to moisture wicking and requires added separation material between panel base and concrete. • Proprietary options exist. Potential suppliers include Simpson Strong-Tie, Rothoblaas, and MiTek. 	2 or 3	High	\$\$	Easy	Easy	Level III
<p>16-4.</p> <p>Panel Bears with Buckets</p>		<p>Purpose: Transfer of vertical load from panel to concrete. Can also transfer in-plane and out-of-plane loads from the panel to concrete.</p> <p>Description: Panel bears on intermittent buckets. Panel is positively connected to bucket using partially threaded screws. Bucket is positively connected to concrete using post-installed anchors. Grout is provided below bucket for elevation control.</p> <p>Notes:</p> <ul style="list-style-type: none"> • Capacity of connection is dependent on parallel-to-grain capacity of panel bearing on buckets. • Screws, anchors, and bucket provide load path for in-plane and out-of-plane loads. • Spacing of connection as required for stability and loading requirements. • Connection may be installed without grout. Without grout, the connection does not accommodate likely variations in top of concrete elevations, even within the range of appropriate concrete tolerances. 	2	Low	\$\$\$	Moderate	Easy	Level III

Table 16: Mass Timber Wall Panel Base at Concrete

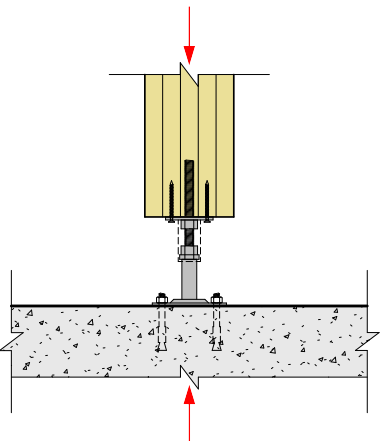
Connection Type	Image	Designer Notes	Class	Load	Cost	Const	Inspect	Fire
16-5. Panel Bears with Continuous Proprietary Shoe		<p>Purpose: Transfer of vertical load from panel to concrete. Can also transfer in-plane and out-of-plane loads from the panel to concrete.</p> <p>Description: Panel bears on continuous proprietary shoe. Panel is positively connected to shoe using partially-threaded screws at shoe side plate. Shoe is positively connected to concrete using post-installed anchors. Grout is provided below shoe for elevation control and bearing.</p> <p>Notes:</p> <ul style="list-style-type: none"> • Capacity of connection is dependent on the manufacturer’s literature. • Screws, anchors, and shoe provide load path for in-plane and out-of-plane loads. • Potential suppliers include Alufoot. 	3	High	\$\$\$	Moderate	Advanced	Level III
16-6. Panel Bears with Knife Plates		<p>Purpose: Transfer of vertical load from panel to concrete. Can also transfer in-plane and out-of-plane loads from the panel to concrete.</p> <p>Description: Panel bears on intermittent steel connection consisting of knife and bearing plate. Knife plate is positively connected to panel with dowel-type fasteners. Bearing plate is positively connected to concrete with post-installed anchors. Grout is provided below bearing plate for elevation control.</p> <p>Notes:</p> <ul style="list-style-type: none"> • Capacity of connection is dependent on the parallel-to-grain capacity of panel or manufacturer’s literature. • Screws, anchors, and knife plate provide load path for in-plane and out-of-plane loads. • Spacing of connection as required for stability and loading requirements. • Connection may be installed without grout under bearing plate. Without grout, the connection does not accommodate likely variations in top of concrete elevations, even within the range of appropriate concrete tolerances. • Proprietary options exist. Potential suppliers include MTC Solutions. 	2 or 3	Medium	\$\$\$	Advanced	Advanced	Level II

Table 16: Mass Timber Wall Panel Base at Concrete

Connection Type	Image	Designer Notes	Class	Load	Cost	Const	Inspect	Fire
16-7. Panel Holddown		<p>Purpose: Transfer of vertical uplift load from panel to concrete.</p> <p>Description: Panel bearing on concrete is connected to concrete with holddown. Panel is connected to holddown with partially-threaded screws. Holddown is connected to concrete with post-installed anchors.</p> <p>Notes:</p> <ul style="list-style-type: none"> • Capacity of connection is dependent on the screw capacity, anchor capacity, or manufacturer’s literature. • Connection may also use embed instead of post-installed anchors in concrete. • Refer to other details in this table for gravity load transfer along length of panel to concrete connection. • In high-seismic zones, horizontal screws will result in a more ductile connection. • Proprietary options exist. Potential suppliers include Simpson Strong-Tie, Rothoblaas, and MiTek. 	2 or 3	Medium - high	\$\$-\$\$\$	Moderate	Easy	Level III
16-8. Panel Holddown with Rod System		<p>Purpose: Transfer of vertical uplift load from panel to concrete.</p> <p>Description: Panel bearing on concrete is connected to concrete with embed with welded threaded stud above. Rod systems consists of anchor rod embedded in concrete and oversized plate and nut used to connect panel to rod at notch in panel.</p> <p>Notes:</p> <ul style="list-style-type: none"> • Capacity of connection is dependent on parallel to grain capacity of panel at oversized washer or shear capacity of the panel. • Connection may also use post-installed or cast-in anchor instead of embed in concrete. • Refer to other details in this table for gravity load transfer along length of panel to concrete connection. 	2	Medium - high	\$\$	Advanced	Easy	Level II

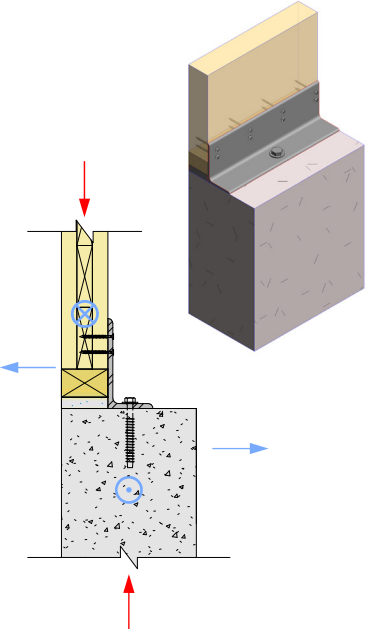
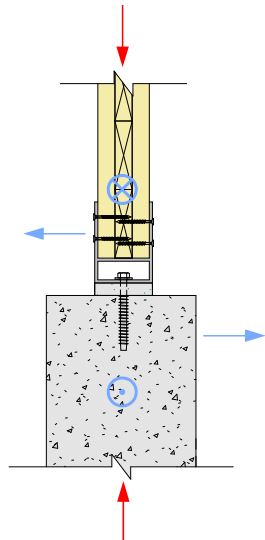
Table 16: Mass Timber Wall Panel Base at Concrete

Connection Type	Image	Designer Notes	Class	Load	Cost	Const	Inspect	Fire
16-9. Panel Holddown with Multi-Story Rod System		<p>Purpose: Transfer of vertical uplift load from panel to concrete.</p> <p>Description: Panel bearing on concrete is connected to concrete with embed with welded threaded stud above. Rod system consists of full-height anchor rod at notch in the side of the panel with oversized plates and couplers as necessary to connect panel to rod.</p> <p>Notes:</p> <ul style="list-style-type: none"> • Capacity of connection is dependent on parallel-to-grain capacity of panel at oversized washer or shear capacity of the panel. • Designer should consider wood shrinkage in final connection condition. • Refer to other details in this table for gravity load transfer along length of panel to concrete connection. 	2	Medium - high	\$\$	Advanced	Easy	Level II
16-10. Panel Holddown with Proprietary Connection System		<p>Purpose: Transfer of vertical uplift load at panel end from panel to concrete. Can also transfer in-plane loads from the panel to concrete.</p> <p>Description: Panel bears on concrete with notch at panel corner for connection system. One portion of connection system is shop-installed on panel and attached with partially threaded screws. Second portion of connection is installed on site and attached to concrete with post-installed anchors. Connection is completed with bolts through both portions of connection system.</p> <p>Notes:</p> <ul style="list-style-type: none"> • Capacity of connection is dependent on the manufacturer's literature. • Coordination with supplier required prior to fabrication to facilitate shop installation of connector. • All fasteners in system are as specified by system manufacturer. • Base of wood wall panel requires added separation material to reduce the likelihood of moisture wicking into the panel. This material may also assist in correcting imperfections at top of concrete. • Refer to other details in this table for gravity load transfer along length of panel to concrete connection. • Potential suppliers include Rothoblaas. <p>Other Applications:</p> <ul style="list-style-type: none"> • <i>Table 14: Mass Timber Wall Panel to Mass Timber Wall Panel</i> 	3	Medium	\$\$\$\$	Advanced	Easy	Level III

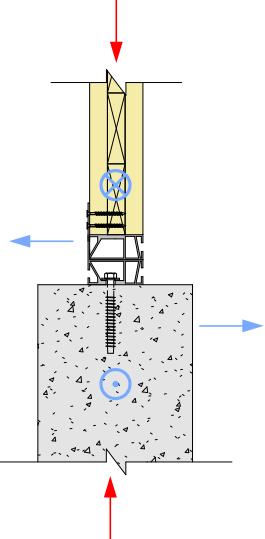
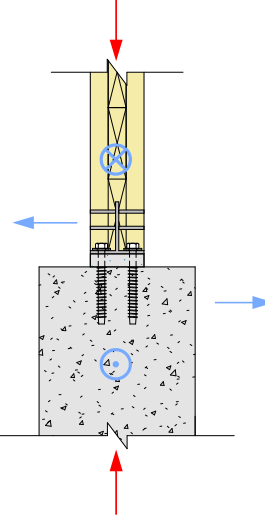
Table 16: Mass Timber Wall Panel Base at Concrete

Architectural Connections Nomenclature

Each assembly/connection in the index is categorized as follows:

- **Assembly/Connection Type:** Brief description of the assembly or connection in terms of what is required for the installation.
- **Image:** Graphic detail showing the assembly or connection.
- **Designer Notes:**
 - o Purpose: The main reason for the use of the assembly or connection.
 - o Description: Describes why the assembly or connection could be required.
 - o Notes: Important considerations for the designer, such as alternates, suggestions, and potential challenges in design and construction.
- **Acoustics:** Assumed acoustic performance, including both STC and IIC levels based on the example provided. For acoustical ratings of similar assemblies, see the **WoodWorks Inventory of Acoustically-Tested Mass Timber Assemblies**.
- **Constructability (Const):** The assumed ease at which the assembly or connection can be built.
 - o Easy: Simple construction with limited schedule impact.
 - o Medium: More complex construction with some schedule impact.
 - o Hard: Difficult construction with the potential for significant schedule impact.
- **Fire Rating:**
 - o Non-rated: This assembly or connection cannot maintain a listed fire rating.
 - o Fire rated: This assembly or connection can maintain a certain rating called out in this section. Assemblies or connections identified as rated are included in the **WoodWorks Inventory of Fire Resistance-Tested Mass Timber Assemblies & Penetrations** or manufacturer's literature. See the WoodWorks inventory for additional fire-resistance-tested assemblies.

Table 17: Floor/Ceiling Assemblies

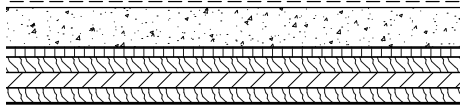
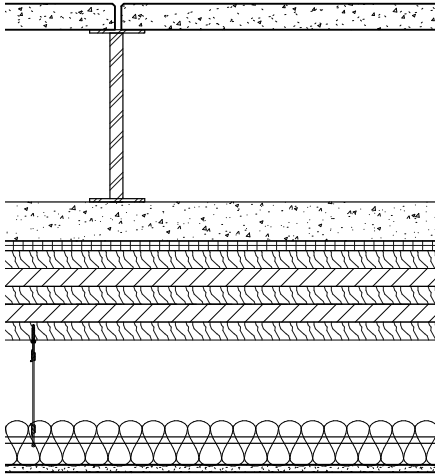
Assembly / Connection Type	Image	Designer Notes	Acoustics	Const	Fire
<p>17-1.</p> <p>Typical 3-Ply CLT Floor/Exposed Ceiling Assembly</p>		<p>Purpose: CLT floor assembly with concrete/gypsum topping (ceiling side exposed)</p> <p>Description:</p> <ul style="list-style-type: none"> • Minimum 3/4"-thick floor topping with minimum compressive strength of 1800 psi; reinforce topping slab as required • Sound insulation board • CLT panels <p>Notes:</p> <ul style="list-style-type: none"> • Topping options: <ul style="list-style-type: none"> - Normal or lightweight concrete - Gypsum concrete floor • Sound insulation options: <ul style="list-style-type: none"> - Thickness varies; thicker mat will provide better acoustic separation 	<p>3-ply CLT (3.5" total thickness) with 3" normal weight concrete with Maxxon Acousti-Mat III (3/4"-thick) = IIC 45 & STC 53</p>	<p>Easy</p>	<p>Non-rated 3-ply CLT 1 1/2-hr rating possible: 5-ply CLT Design No. L901</p>
<p>17-2.</p> <p>Typical 5-Ply CLT Floor with Raised Plenum Floor/Concealed Ceiling</p>		<p>Purpose: CLT floor assembly with concrete/gypsum topping (ceiling side concealed)</p> <p>Description:</p> <ul style="list-style-type: none"> • Concrete access floor panel with adjustable pedestals • Minimum 3/4"-thick floor topping with minimum compressive strength of 1800 psi; reinforce topping slab as required • Sound insulation board • CLT panels • 1/2" resilient channel, 5/8" gypsum board, suspended ceiling (24"-deep plenum) with 3 1/2" mineral wool batt insulation, 5/8" gypsum board <p>Notes:</p> <ul style="list-style-type: none"> • Topping options: <ul style="list-style-type: none"> - Normal or lightweight concrete - Gypsum concrete floor • Sound insulation options: <ul style="list-style-type: none"> - Thickness varies; thicker mat will provide better acoustic separation 	<p>5-ply CLT (6.875" total thickness) with 3/4" Gyp-Crete, with Maxxon Acousti-Mat 1/8" with suspended ceiling (24"-deep plenum) with 3-1/2" mineral wood batt insulation, 5/8" gypsum board = STC 54 & IIC 56</p>	<p>Easy</p>	<p>Non-rated 3-ply CLT 1 1/2-hr rating possible: 5-ply CLT Design No. L901</p>

Assembly / Connection Type	Image	Designer Notes	Acoustics	Const	Fire
<p>17-3.</p> <p>Typical 5-Ply CLT Floor with Concealed Ceiling</p>		<p>Purpose: CLT floor assembly with concrete/gypsum topping (ceiling side concealed)</p> <p>Description:</p> <ul style="list-style-type: none"> • Minimum 3/4"-thick floor topping with minimum compressive strength of 1800 psi; reinforce topping slab as required • Sound insulation board • CLT panels • 5/8" Type X gypsum <p>Notes:</p> <ul style="list-style-type: none"> • Topping options: <ul style="list-style-type: none"> - Normal or lightweight concrete - Gypsum concrete floor • Sound insulation options: <ul style="list-style-type: none"> - Thickness varies; thicker mat will provide better acoustic separation 	<p>5-ply CLT (6.875" total thickness) with 2" concrete with Maxxon Acousti-Mat SBR over Maxxon Acousti-Mat (3/4"-thick) with 2 layers 5/8" Type X gypsum = STC 58 & IIC 55</p>	<p>Easy</p>	<p>Non-rated 3-ply CLT 1 1/2-hr rating possible; 5-ply CLT Design No. L901</p>

Table 18: Roof Details

Assembly / Connection Type	Image	Designer Notes	Acoustics	Const	Fire
<p>18-1.</p> <p>Typical Roof Assembly with Rigid Insulation & TPO*</p> <p><i>*Thermoplastic polyolefin</i></p>		<p>Purpose: CLT roof assembly with sloped rigid insulation and TPO (ceiling side exposed)</p> <p>Description:</p> <ul style="list-style-type: none"> • Roofing membrane • 1 1/2" cover board • Roofing insulation • CLT panels <p>Notes:</p> <ul style="list-style-type: none"> • If rating is required, a topping will need to be added to the assembly. • Thickness of rigid insulation varies depending on energy code requirements. 	<p>3-ply CLT = IIC 22 & STC 38 5-ply CLT = IIC 25 & STC 41</p> <p>(Rigid board and roofing membrane not included)</p>	<p>Easy</p>	<p>Non-rated 3-ply CLT 1 1/2-hr rating possible: 5-ply CLT Design No. L901</p> <p>Would require adding a topping under the rigid insulation</p>
<p>18-2.</p> <p>Roof Drain and Overflow at CLT Roof Deck</p>		<p>Purpose: Example of roof drains at CLT roof deck detail</p> <p>Description:</p> <ul style="list-style-type: none"> • Primary and overflow drains with sloped insulation and lag screw attachment located in CLT deck <p>Notes:</p> <ul style="list-style-type: none"> • Cast iron locking dome with non-puncture clamp ring recommended • Through bolt would be an alternative but bolts would be exposed at underside of deck 	<p>3-ply CLT = IIC 22 & STC 38 5-ply CLT = IIC 25 & STC 41</p> <p>(Rigid board and roofing membrane not included)</p>	<p>Easy</p>	<p>Non-rated 3-ply CLT 1 1/2-hr rating possible: 5-ply CLT Design No. L901</p> <p>Would require adding a topping under the rigid insulation</p>

Assembly / Connection Type	Image	Designer Notes	Acoustics	Const	Fire
<p>18-3.</p> <p>Conduit/Pipe Penetration at CLT Roof Deck</p>		<p>Purpose: Roof penetration for conduit/pipe at CLT roof deck</p> <p>Description:</p> <ul style="list-style-type: none"> • Penetration in CLT is provided either pre-cored or cored in place depending on size of penetration required. <p>Notes:</p> <ul style="list-style-type: none"> • Fire caulk penetration if rated roof • Boot flashing and roof membrane transitions 	<p>3PLY CLT = IIC 22 & STC 38 5 PLY CLT = IIC 25 & STC 41</p> <p>(Rigid board and roofing membrane not included)</p>	<p>Easy</p>	<p>Non-rated 3-ply CLT 1 1/2-hr rating possible: 5-ply CLT Design No. L901</p> <p>Would require adding a topping under the rigid insulation</p>
<p>18-4.</p> <p>Roof Tie-Off at Typical Roof Assembly</p>		<p>Purpose: Typical roof tie-off detail for facade maintenance at CLT roof deck</p> <p>Description:</p> <ul style="list-style-type: none"> • Penetration in CLT is provided either pre-cored or cored in place depending on size of penetration required • Typical roof tie-off mounted to CLT roof deck using base plate with lag screws or bolts <p>Notes:</p> <ul style="list-style-type: none"> • Boot flashing and roof membrane transitions • Blockouts in concrete paver layout required 	<p>3-ply CLT = IIC 22 & STC 38 5-ply CLT = IIC 25 & STC 41</p> <p>(Rigid board and roofing membrane not included)</p>	<p>Easy</p>	<p>Non-rated 3-ply CLT 1 1/2-hr rating possible: 5-ply CLT Design No. L901</p> <p>Would require adding a topping under the rigid insulation</p>

Table 18: Roof Details

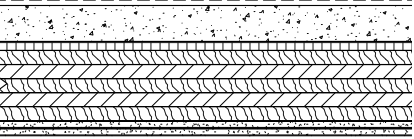
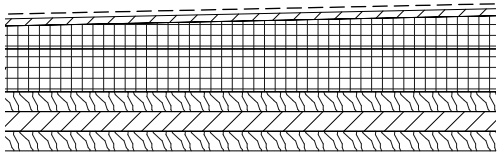
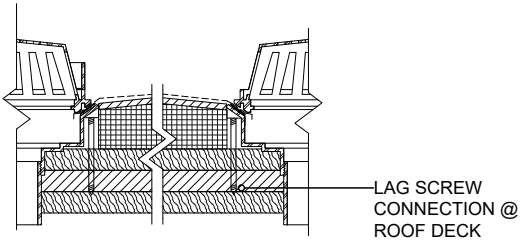
Table 19: Wall Details

Assembly / Connection Type	Image	Designer Notes	Acoustics	Const	Fire
<p>19-1.</p> <p>Shaft Wall Assembly at Non-Rated Floor and 2-Hr Shaft</p>		<p>Purpose: Self-supporting shaft wall assembly</p> <p>Description:</p> <ul style="list-style-type: none"> Required when the CLT floor is not rated and cannot be used to support the rated shaft wall assembly; in this instance, the internal steel structure supports the shaft wall <p>Notes:</p> <ul style="list-style-type: none"> Separate steel structure mounted to concrete podium or foundation below to support shaft wall Internal steel frame supports and braces the shaft wall assembly CLT floor outboard of shaft wall assembly 	<p>Shaft wall assembly estimated at STC 39-45 depending on layers of gyp for shaft rating</p> <p>CLT floor 3-ply (3.5") with 3/4" acoustic mat and 3" concrete = IIC 45 & STC 53</p>	<p>Advanced</p>	<p>1-hr or 2-hr shaft wall rating; CLT floor non-rated</p>
<p>19-2.</p> <p>Shaft Wall Assembly at 1-Hr-Rated Floor and 1-Hr Shaft</p>		<p>Purpose: Shaft wall assembly supported by CLT floor</p> <p>Description:</p> <ul style="list-style-type: none"> Minimum 3/4"-thick floor topping with minimum compressive strength of 1800 psi; reinforce topping slab as required Sound insulation board CLT panels Gypsum shaft wall assembly with batt <p>Notes:</p> <ul style="list-style-type: none"> 5-ply CLT or thicker; cannot be done with 3-ply CLT 	<p>5-ply CLT (6.875" total thickness with 2 1/2" Gyp-Crete with Maxxon Acousti-Mat 3/4 Premium + Acousti-Mat SBR (3/8") = IIC 48 & STC 51.</p>	<p>Easy</p>	<p>Non-rated 3-ply CLT 1 1/2-hr rating possible: 5-ply CLT Design No. L901</p>

Assembly / Connection Type	Image	Designer Notes	Acoustics	Const	Fire
<p>19-3.</p> <p>Shaft Wall Assembly at Bottom of Shaft with Support Beam</p>		<p>Purpose: Maintain rating of base of shaft wall assembly</p> <p>Description:</p> <ul style="list-style-type: none"> Required to provide a rated base to the shaft without using the 3-ply CLT floor to support it; glulam beams support the concrete-filled metal deck <p>Notes:</p> <ul style="list-style-type: none"> Glulam beam used to support the shaft wall and the concrete-filled metal deck shaft floor based on char factor compliance for wall rating CLT floor outboard of shaft wall assembly to maintain shaft wall rating without CLT support 	<p>Shaft wall assembly estimated at STC 39-45 depending on layers of gypsum for shaft rating</p> <p>CLT floor 3-ply (3.5") with 3/4" acoustic mat and 3" concrete = IIC 45 & STC 53</p>	<p>Moderate</p>	<p>Can be used to meet any shaft wall rating requirement based on size of glulam and associated char factor</p>
<p>19-4.</p> <p>Shaft Wall Assembly at Bottom of Shaft with HSS Support</p>		<p>Purpose: Alternate option to maintain rating at base of shaft wall assembly</p> <p>Description:</p> <ul style="list-style-type: none"> Required to provide a rated base to the shaft without using the 3-ply CLT floor to support it; glulam beams support the concrete-filled metal deck HSS internal steel support for tall shaft wall assembly <p>Notes:</p> <ul style="list-style-type: none"> Glulam beam used to support shaft wall and the concrete-filled metal deck shaft floor based on char factor compliance for wall rating CLT floor outboard of shaft wall assembly to maintain shaft wall rating without CLT support HSS steel shaft wall support mounted to the glulam below 	<p>Shaft wall assembly estimated at STC 39-45 depending on layers of gypsum for shaft rating</p> <p>CLT floor 3-ply (3.5") with 3/4" acoustic mat and 3" concrete = IIC 45 & STC 53</p>	<p>Moderate</p>	<p>Can be used to meet any shaft wall rating requirement based on size of glulam and associated char factor</p>

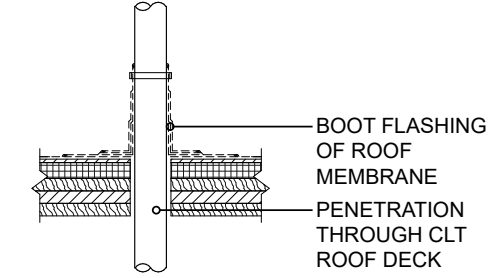
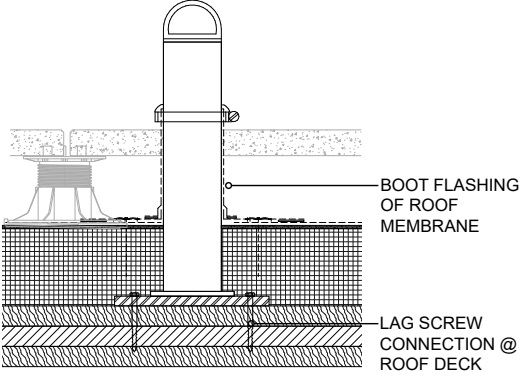
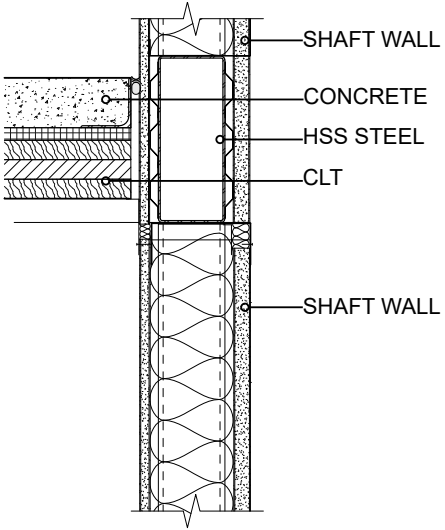
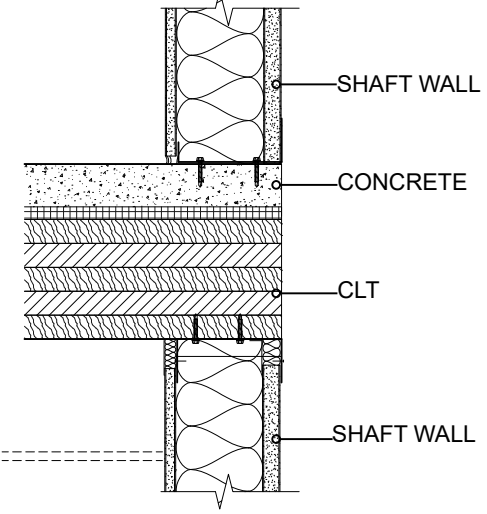
Table 19: Wall Details

Assembly / Connection Type	Image	Designer Notes	Acoustics	Const	Fire
<p>19-5.</p> <p>Shaft Wall Assembly at Non-Rated Floor and 1-Hr Shaft with Concrete Turned Down Beam</p>		<p>Purpose: Shaft wall assembly at intermediate floors and glulam beams</p> <p>Description:</p> <ul style="list-style-type: none"> 3-ply CLT cannot be in the shaft wall assembly so the turned down concrete beam provides the transition from the shaft wall to the beam <p>Notes:</p> <ul style="list-style-type: none"> Concrete turned down beam and glulam beam used to support the shaft wall and maintain rating CLT floor outboard of the shaft wall assembly 	<p>Shaft wall assembly estimated at STC 39-45 depending on layers of gypsum for shaft rating</p> <p>CLT floor 3-ply (3.5") with 3/4" acoustic mat and 3" concrete = IIC 45 & STC 53</p>	<p>Moderate</p>	<p>Can be used to meet any shaft wall rating requirement based on size of glulam and associated char factor</p>
<p>19-6.</p> <p>Shaft Wall Assembly at Non-Rated Floor and 2-Hr Shaft with Concrete Turned Down Beam</p>		<p>Purpose: Shaft wall assembly at intermediate floors with glulam beam support</p> <p>Description:</p> <ul style="list-style-type: none"> Intermediate floor transition at shaft. 3-ply CLT cannot be in the shaft wall assembly so the turned down concrete beam provides the transition between floors where no beam is present <p>Notes:</p> <ul style="list-style-type: none"> Reinforced self-supporting concrete turned down beam used to support the shaft wall and maintain rating CLT floor outboard of shaft wall assembly Formwork and shoring required to cast turned down concrete beam where glulam beam is not present 	<p>Shaft wall assembly estimated at STC 39-45 depending on layers of gypsum for shaft rating</p> <p>CLT floor 3-ply (3.5") with 3/4" acoustic mat and 3" concrete = IIC 45 & STC 53</p>	<p>Advanced</p>	<p>Can be used to meet any shaft wall rating requirement</p>

Table 19: Wall Details

Assembly / Connection Type	Image	Designer Notes	Acoustics	Const	Fire
<p>19-7.</p> <p>CLG Hung Support Hung from Underside of CLT Floor</p>	 <p>CLT</p> <p>L-ANGLE SUPPORTS</p> <p>RESTROOM GYP CLG.</p>	<p>Purpose: CLG hung support mounted to underside or CLT floor</p> <p>Description:</p> <ul style="list-style-type: none"> • Assembly for mounting ceiling-supported elements hung from the CLT floor above (e.g., for toilet partitions, heavy light fixtures, artwork, etc.) <p>Notes:</p> <ul style="list-style-type: none"> • L-angle supports mounted to underside of CLT with lag screws • Threaded rod used off bottom of support plate • L-angle supports and brace bolted together • 5/8" gypsum board, suspended ceiling (24"-deep plenum) with 3 1/2" mineral wool batt insulation, 5/8" gypsum board 	<p>5-ply CLT (6.875" total thickness) with 3/4" Gyp-Crete over Maxxon Acousti-Mat 1/8" = IIC 56 & STC 54</p>	<p>Easy</p>	<p>Non-rated 3-ply CLT 1 1/2-hr rating possible: 5-ply CLT Design No. L901</p>
<p>19-8.</p> <p>Typical Interior Demising Wall</p>	 <p>CLT</p> <p>DEMISING WALL</p> <p>CONCRETE TOPPING SLAB</p>	<p>Purpose: Typical interior demising wall mounted to CLT floor above and topping below</p> <p>Description:</p> <ul style="list-style-type: none"> • Two layers of gypsum both sides; 2 1/2"-deep leg track at head for floor movement; lag screws used at underside of CLT; powder actuated fastener for attachment to topping <p>Notes:</p> <ul style="list-style-type: none"> • One layer of gypsum could be substituted for resilient channel to improve STC rating • Provide batt insulation in the cavity 	<p>5/8" Type X, one layer one side 3 1/2" - 4" batt (STC 50) 5/8" one layer side one, two layers side two, 5/8" Type X, 3 1/2" - 4" batt (STC 55) 5/8" Type X, two layers each side 3 1/2" - 4" batt (STC</p>	<p>Easy</p>	<p>Non-rated 3-ply CLT 1 1/2-hr rating possible: 5-ply CLT Design No. L901</p>

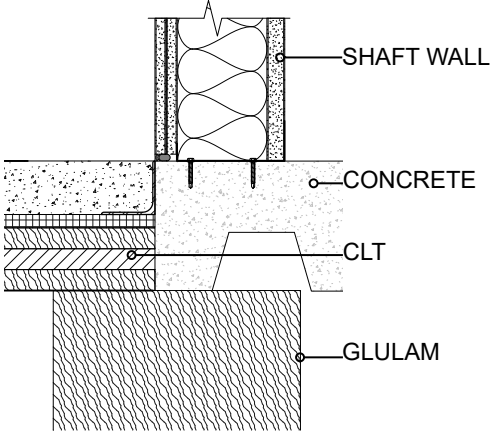
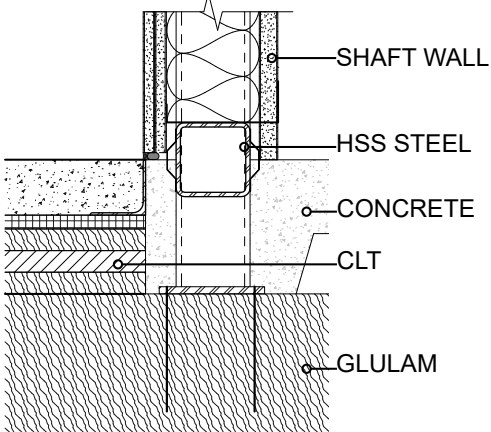
Table 19: Wall Details

Assembly / Connection Type	Image	Designer Notes	Acoustics	Const	Fire
<p>19-9.</p> <p>Exterior Brick Wall Attachment to CLT Floor</p>		<p>Purpose: Exterior wall attachment to CLT floor</p> <p>Description:</p> <ul style="list-style-type: none"> Connects exterior wall studs to CLT floor bypassing the building structure, while allowing for vertical deflection of the structure up to 2" (1" up and 1" down) <p>Notes:</p> <ul style="list-style-type: none"> Surface-mounted clip; needs to be installed prior to acoustic mat and topping <p>Alternate attachment methods:</p> <ul style="list-style-type: none"> Clip installed at bottom of CLT instead of top Thicker CLT panel with clips attached directly to edge of panel; for this scenario, must ensure that screws from the clips to the CLT are not in the end-grain of the wood Use a continuous angle along the edge of the CLT, which could be the structural chord; attachment of the wall is to the angle instead of the CLT 	<p>Thermafiber Safing and smoke seal used at space between floor and wall, both for acoustic and smoke separation</p>	<p>Easy</p>	<p>1-hr or 2-hr exterior wall rating based on interior layers of gypsum</p> <p>Non-rated 3-ply CLT 1 1/2-hr rating possible: 5-ply CLT Design No. L901</p>
<p>19-10.</p> <p>Curtain Wall Attachment to Rated Floor</p>		<p>Purpose: Intermediate floor transition detail for curtain wall and rated floor assembly</p> <p>Description:</p> <ul style="list-style-type: none"> Typical curtain wall transition using CW-D-1014 floor transition assembly to maintain rating Attachment method for the curtain wall to the CLT in this detail is mounted to the top of the CLT <p>Notes:</p> <ul style="list-style-type: none"> Surface-mounted anchor; needs to be installed prior to acoustic mat and topping Steel bent plate with lag screws Minimum 5-ply CLT required for floor rating up to 1 1/2" hr Pre-finished steel back pan only recommended when no ceiling is used to cover the Thermafiber behind the spandrel at the floor transition Custom work by curtain wall suppliers may be needed to interface with the timber 	<p>Thermafiber Safing and smoke seal used at space between floor and wall both for acoustic and smoke separation</p>	<p>Moderate</p>	<p>1 1/2-hr rating possible: 5-ply CLT Design No. L901</p>

Table 19: Wall Details

Assembly / Connection Type	Image	Designer Notes	Acoustics	Const	Fire
<p>19-11.</p> <p>Curtain Wall Attachment to Non-Rated Floor</p>		<p>Purpose: Intermediate floor transition detail for curtain wall and non-rated floor assembly</p> <p>Description:</p> <ul style="list-style-type: none"> Attachment method for the curtain wall to the CLT in this detail is mounted to the top of the CLT <p>Notes:</p> <ul style="list-style-type: none"> Surface-mounted anchor; needs to be installed prior to acoustic mat and topping Steel bent plate with lag screws Pre-finished brake metal wrap only recommended when no ceiling is used to cover the Thermafiber at the floor transition Custom work by curtain wall suppliers may be needed to interface with the timber 	<p>Thermafiber Safing and smoke seal used at space between floor and wall, both for acoustic and smoke separation</p>	<p>Moderate</p>	<p>Non-rated floor and wall assembly</p>
<p>19-12.</p> <p>Curtain Wall Attachment to Non-Rated Floor at Overhang</p>		<p>Purpose: Detail for curtain wall and non-rated floor assembly at overhang</p> <p>Description:</p> <ul style="list-style-type: none"> Attachment method for the curtain wall to the CLT in this detail is mounted to the top of the CLT; bottom of the curtain wall is hung off this attachment and framing provided off the bottom of the CLT to support the overhang material <p>Notes:</p> <ul style="list-style-type: none"> Surface-mounted anchor; needs to be installed prior to acoustic mat and topping Steel bent plate with lag screws Pre-finished brake metal wrap is only recommended when no ceiling is used to cover the Thermafiber at the floor transition. Custom work by curtain wall suppliers may be needed to interface with the timber 	<p>Thermafiber Safing and smoke seal used at space between floor and wall, both for acoustic and smoke separation</p>	<p>Moderate</p>	<p>Non-rated floor and wall assembly</p>

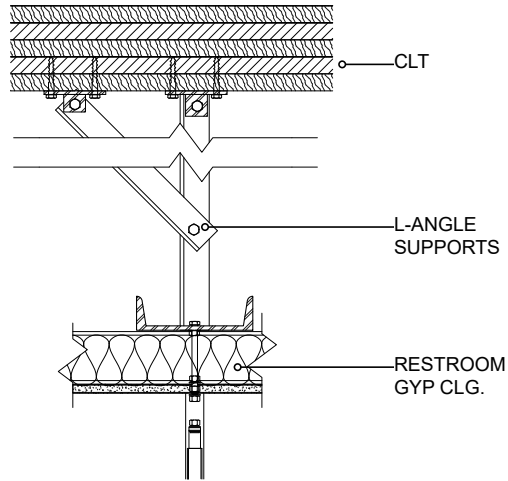
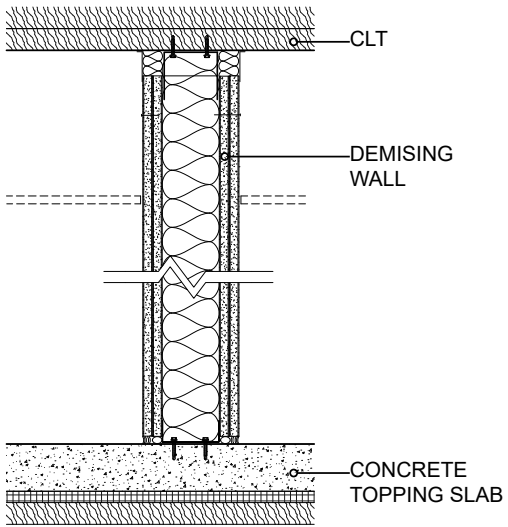
Table 19: Wall Details

Assembly / Connection Type	Image	Designer Notes	Acoustics	Const	Fire
<p>19-13.</p> <p>Curtain Wall Attachment to Non-Rated Roof</p>		<p>Purpose: Roof attachment for curtain wall</p> <p>Description:</p> <ul style="list-style-type: none"> Attachment method for the curtain wall to the CLT in this detail is mounted to the top of the CLT and is different than the intermediate floor attachment <p>Notes:</p> <ul style="list-style-type: none"> Surface-mounted anchor; needs to be installed prior to installation of parapet wall framing Steel bent plate with lag screws Thermafiber required at gap between roof and curtain wall. Custom work by curtain wall suppliers may be needed to interface with the timber 	<p>Thermafiber Safing and smoke seal used at space between floor and wall, both for acoustic and smoke separation</p>	<p>Moderate</p>	<p>Non-rated 3-ply CLT. 1 1/2-hr rating possible: 5-ply CLT Design No. L901</p> <p>Would require adding a topping under the rigid insulation</p>
<p>19-14.</p> <p>Exterior Wall Attachment to CLT Floor at Glazed Openings</p>		<p>Purpose: Exterior wall attachment to CLT floor at glazed openings</p> <p>Description:</p> <ul style="list-style-type: none"> Connects exterior wall studs to CLT floor, bypassing the building structure while allowing vertical deflection of the structure up to 2" (1" up and 1" down) <p>Notes:</p> <ul style="list-style-type: none"> Surface-mounted clip; needs to be installed prior to acoustic mat and topping <p>Alternate attachment methods:</p> <ul style="list-style-type: none"> Clip installed at bottom of CLT instead of top Thicker CLT panel, with clips attached directly to edge of panel; for this scenario, need to ensure that the screws from the clips to the CLT are not in the end grain of the wood Use a continuous angle along the edge of the CLT, which could be the structural chord; attachment of the wall is to the angle instead of the CLT 	<p>Thermafiber Safing and smoke seal used at space between floor and wall, both for acoustic and smoke separation</p>	<p>Easy</p>	<p>1-hr or 2-hr exterior wall rating based on interior layers of gypsum.</p> <p>Non-rated 3-ply CLT 1 1/2-hr rating possible: 5-ply CLT Design No. L901</p>

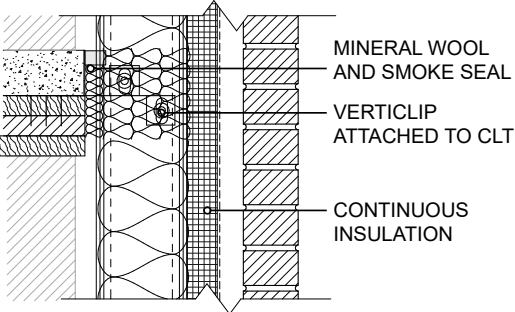
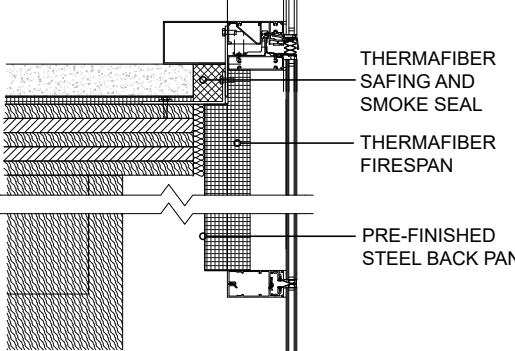
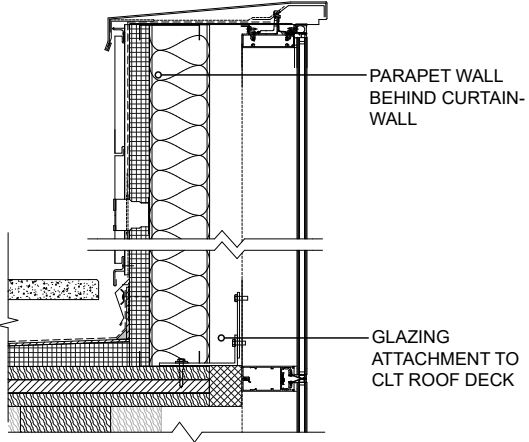
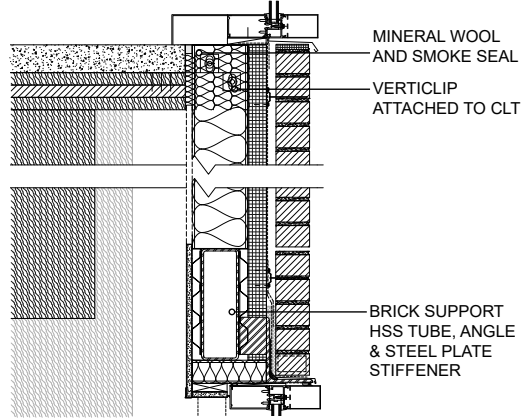
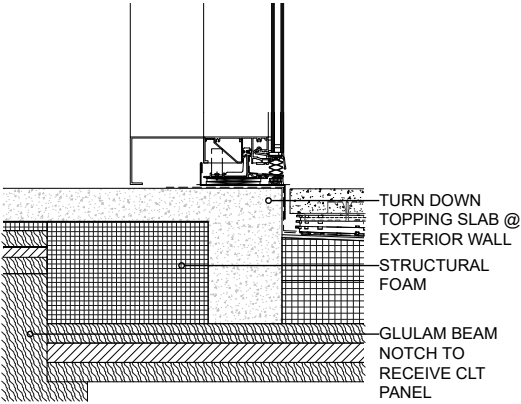
Table 19: Wall Details

Assembly / Connection Type	Image	Designer Notes	Acoustics	Const	Fire
<p>19-15.</p> <p>CLT Terrace at Curtain Wall Curb with Pavers</p>		<p>Purpose: CLT terrace at curtain wall curb with pavers</p> <p>Description:</p> <ul style="list-style-type: none"> To provide the depth needed for pavers and weather barrier, there needs to be a step in the CLT deck <p>Notes:</p> <ul style="list-style-type: none"> Confirm required return up wall with weather barrier membrane manufacturer to determine step depth; for TPO it is 8" minimum vertical return). Concrete curb under curtain wall supported by lower CLT deck Structural foam in fill main floor slab. Support as needed depending on where beam lines up with edge of step 	<p>3-ply CLT = IIC 22 & STC 38 5-ply CLT = IIC 25 & STC 41</p> <p>(Rigid board and roofing membrane not included)</p>	<p>Moderate</p>	<p>Non-rated 3-ply CLT 1 1/2-hr rating possible: 5-ply CLT Design No. L901</p> <p>Would require adding a topping under the rigid insulation</p>