

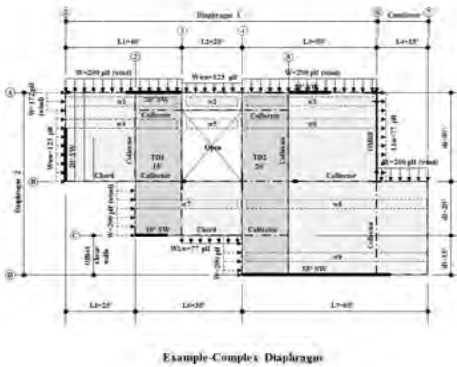

Part I-Offset Diaphragms

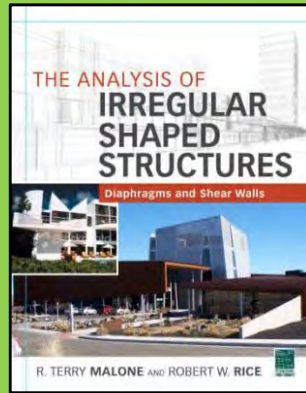

Excerpts From:



Presentation updated to 2012 IBC, ASCE 7-10
Copyright McGraw-Hill, ICC

By: R. Terry Malone, PE, SE
Senior Technical Director
Architectural & Engineering
Solutions

terrym@woodworks.org



Copyright Materials

This presentation is protected by US and International Copyright laws. Reproduction, distribution, display and use of the presentation without written permission of the speaker is prohibited.

© The Wood Products Council 2014

“The Wood Products Council” is a Registered Provider with The American Institute of Architects Continuing Education Systems (AIA/CES), Provider #G516.

Credit(s) earned on completion of this course will be reported to AIA CES for AIA members. Certificates of Completion for both AIA members and non-AIA members are available upon request.

This course is registered with AIA CES for continuing professional education. As such, it does not include content that may be deemed or construed to be an approval or endorsement by the AIA of any material of construction or any method or manner of handling, using, distributing, or dealing in any material or product.

Questions related to specific materials, methods, and services will be addressed at the conclusion of this presentation.



Course Description

Lateral force resisting systems in today’s structures are much more complex than they were several decades ago, incorporating multiple horizontal and vertical offsets in the diaphragms, multiple irregularities, and fewer lateral resisting elements. This two part presentation will provide a brief review of the method used to analyze these complex structures. In part 1, topics will include code requirements, how to recognize diaphragm irregularities and discontinuities, how shears are distributed through complex diaphragms, the method of analysis used to solve the transfer of forces across areas of discontinuity, and the analysis of flexible wood sheathed or untopped steel decking diaphragms with horizontal offsets.



> Learning Objectives

- **Basic Information**

Discuss boundary elements, complete lateral resisting load path requirements and related code sections.

- **Examine Common Types of Discontinuities**

Examine common types of discontinuities and irregularities and discuss how to establish complete lateral load paths across areas of discontinuity.

- **Discuss the Analytical Method of Analysis**

Review an analytical method used for solving complex diaphragms and shear walls using “Transfer Diaphragms” and the “Visual Shear Transfer Method.”

- **Offset Diaphragms-Examples**

Review the analysis of flexible offset diaphragms for loading in the transverse and longitudinal directions.

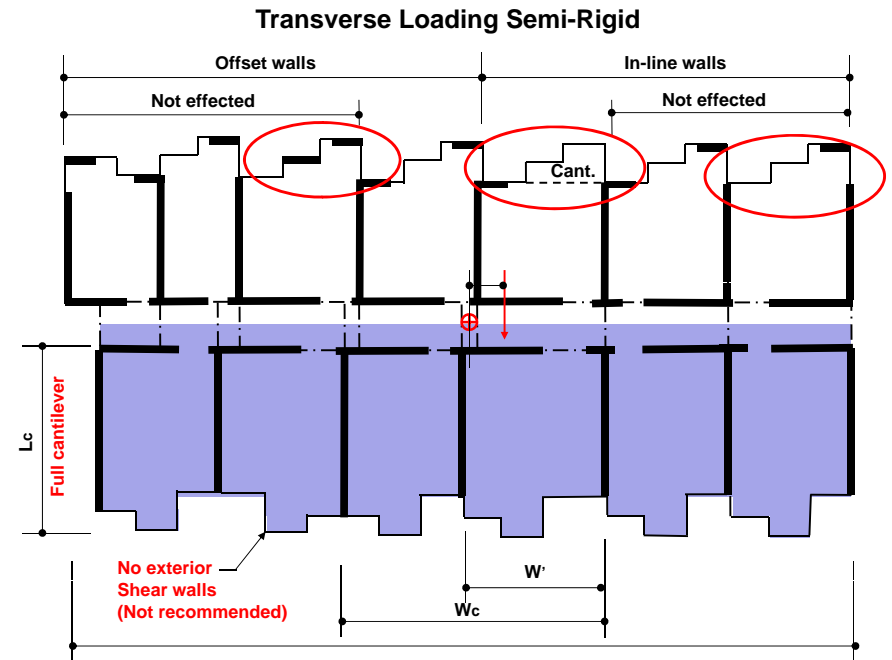

Presentation Assumptions

Flexible wood sheathed or un-topped steel deck diaphragms

The method of analysis is also relevant to internal load path analysis within semi-rigid diaphragms.

- Loads to diaphragms and shear walls
 - Strength level or allowable stress design
 - Wind or seismic forces (UNO).
- The loads are already factored for the appropriate load combination.

Code References:

- ASCE 7-10 “Minimum Design Loads for Buildings and Other Structures”
- 2012 IBC

Design references:

- The Analysis of Irregular Shaped Structures: Diaphragms and Shear Walls- Malone, Rice
- Design of Wood Structures- Breyer, Fridley, Pollock, Cobeen
- SEAOC Seismic Design Manual, Volume 2
- Wood Engineering and Construction Handbook-Faherty, Williamson
- Guide to the Design of Diaphragms, Chords and Collectors-NCSEA, Mays

Basic Information

- **Boundary Elements**
- **Complete Load Paths**
- **Method of Analysis**



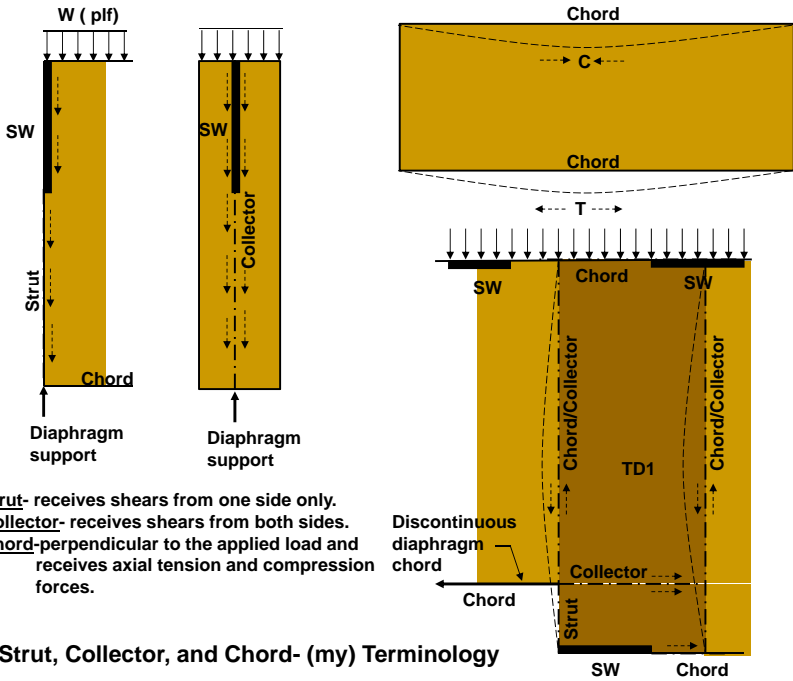

Strut- receives shears from one side only.
Collector- receives shears from both sides.
Chord-perpendicular to the applied load and receives axial tension and compression forces.

Strut, Collector, and Chord- (my) Terminology

Diaphragm Boundary Elements

Fundamental Principles:

A shear wall is a location where diaphragm forces are resisted (supported), and therefore defines a diaphragm boundary location.

Note: All edges of a diaphragm shall be supported by a boundary element.

- **Diaphragm Boundary Elements:**
 - Chords, drag struts, collectors, Shear walls, frames
 - Boundary member locations:
 - Diaphragm and shear wall perimeters
 - Interior openings
 - Areas of discontinuities
 - Re-entrant corners.
- Diaphragm and shear wall sheathing shall not be used to splice boundary elements.
- Collector elements shall be provided that are capable of transferring forces originating in other portions of the structure to the element providing resistance to those forces.

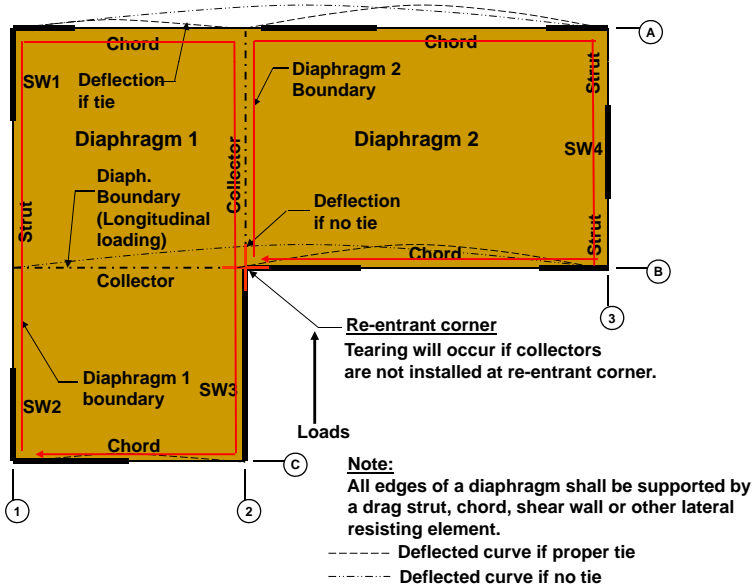
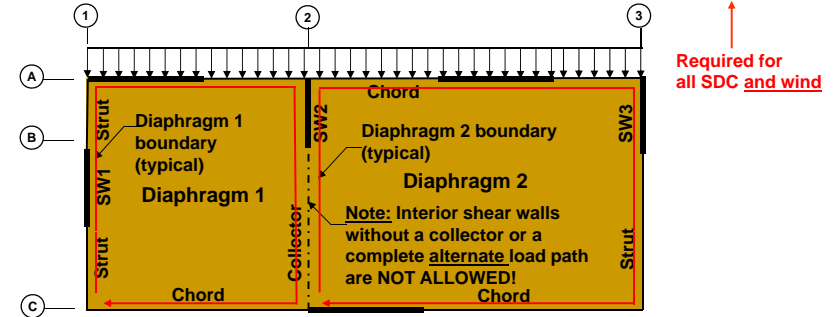

Boundary Elements "L" Shaped Buildings-Transverse Loading

Basic Information

- Boundary Elements
- Complete Load Paths
- Method of Analysis



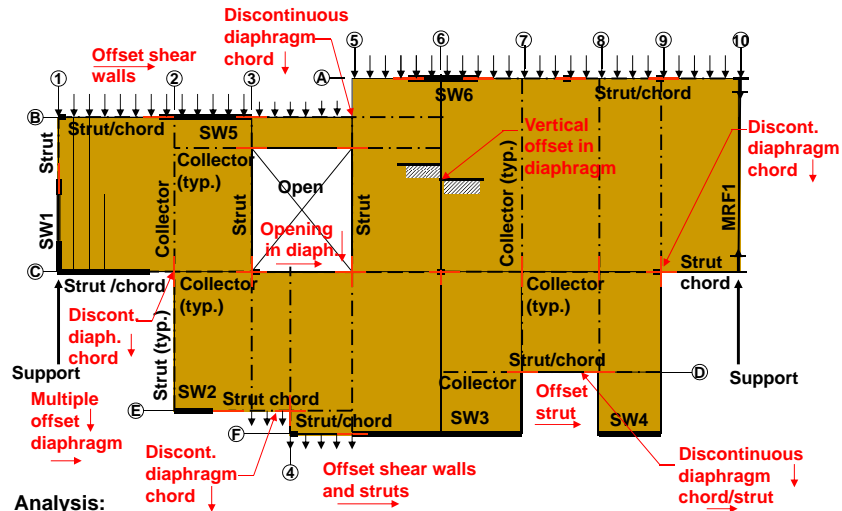

Analysis:

- Design shall be based on a rational analysis
- Complete load path from point of origin to lateral force resisting element (includes members and their connections and splices)
- Openings in shear panels that materially effect their strength shall be fully detailed on the plans and shall have their edges adequately reinforced to transfer all shear stresses.

Complete Continuous Lateral Load Paths

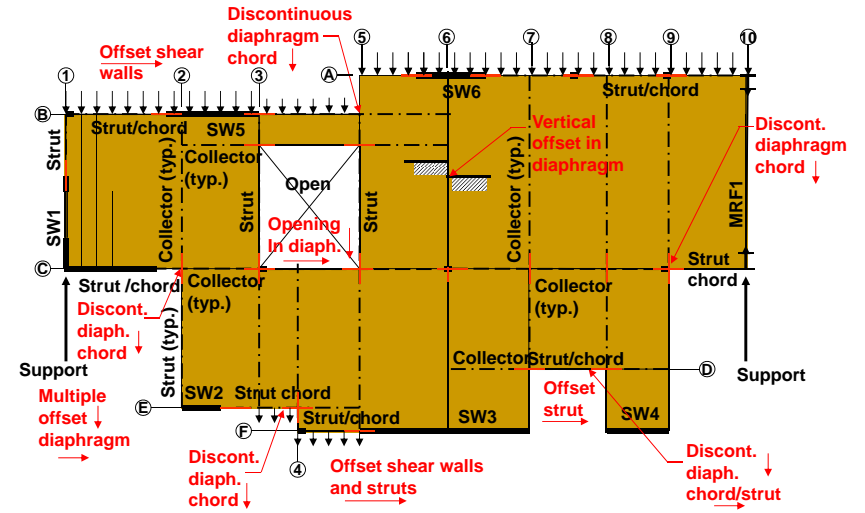

- ASCE 7-10 section 12.10.1-At diaphragm discontinuities such as openings and re-entrant corners, the design shall assure that the dissipation or transfer of edge (chord) forces combined with other forces in the diaphragm is within shear and tension capacity of the diaphragm.

What does this mean?

Basic Information

- Boundary Elements
- Complete Load Paths
- Method of Analysis



Method of Analysis

The Visual Shear Transfer Method

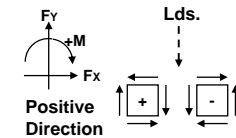
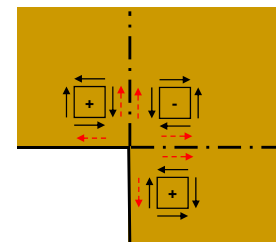
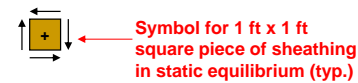

Transverse Direction (shown)

Shears Applied to Sheathing Elements

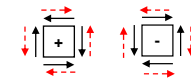

↑ Unit shear acting on sheathing element (plf)

↑ Unit shear transferred from the sheathing element into the boundary element (plf)

Shears Transferred Into Boundary Elements

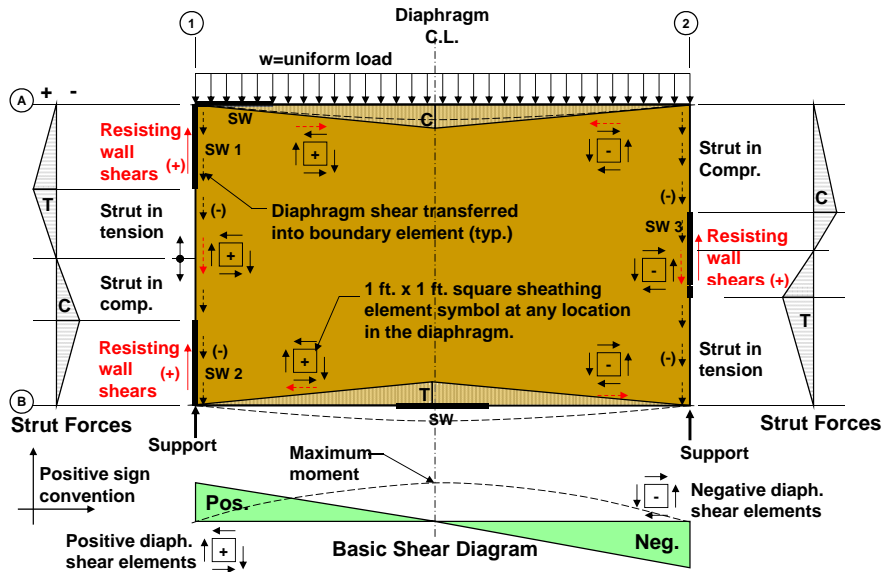

All edges of a diaphragm shall be supported by a boundary element (chord, strut, collector) or other vertical lateral force resisting element (shear wall, frame).
Shear Distribution Into a Simple Diaphragm
The Visual Shear Transfer Method

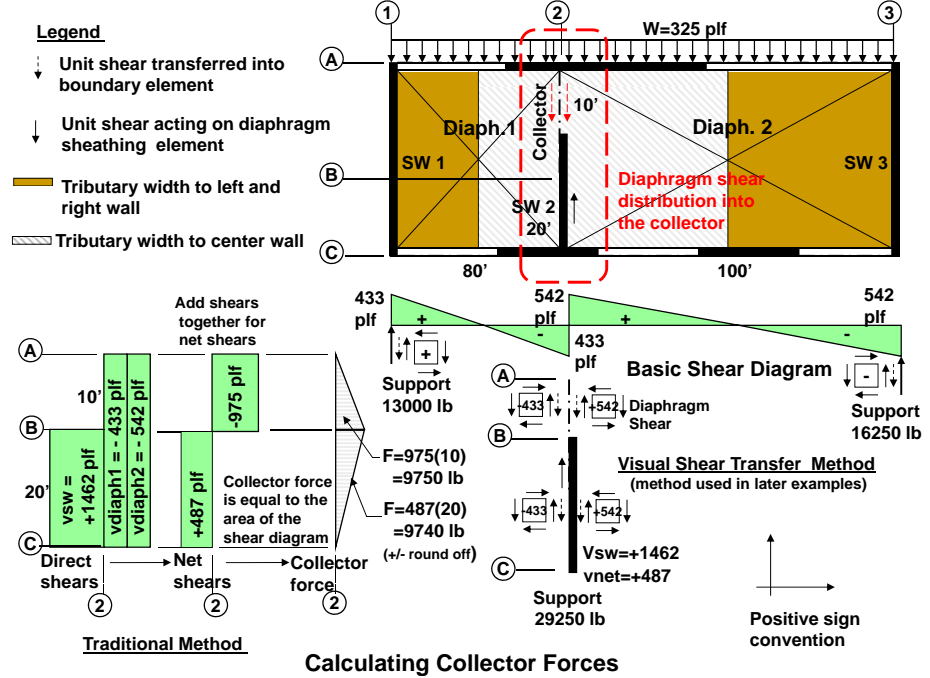

Calculating Collector Forces

Introduction to Transfer Diaphragms and Transfer Areas

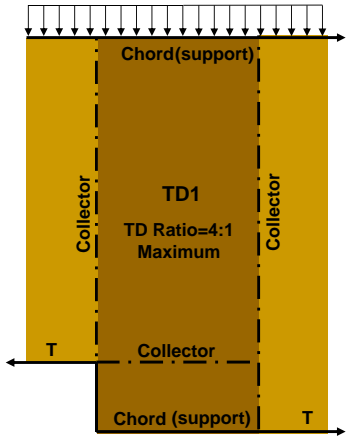

- Transfer Diaphragm (sub-diaphragm):** A portion of a larger diaphragm designed to anchor and transfer local forces to primary diaphragm chords/struts of the main diaphragm.
- At discontinuities, such as openings or re-entrant corners, the design shall assure that the dissipation or transfer of edge (chord) forces **combined with other forces in the diaphragm** is within shear and tension capacity of the diaphragm. *What does this mean?*
- Framing members, blocking, and connections shall extend into the diaphragm a **sufficient distance** to develop the force transferred into the diaphragm. *What does this mean?*

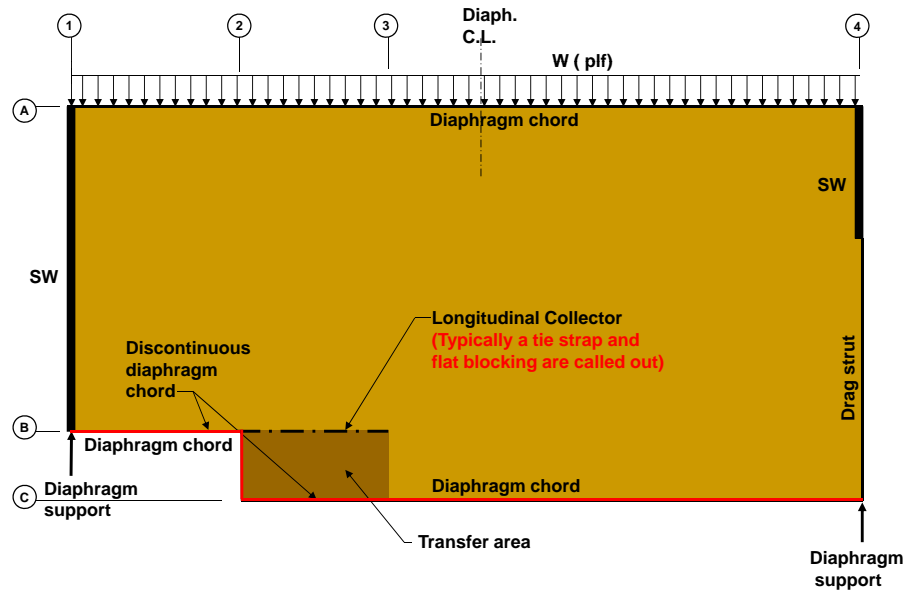

Transfer Diaphragm Members and Elements

Partial length collectors do not constitute a complete load path.

This force must be transferred out to the main chords. A complete load path is required.

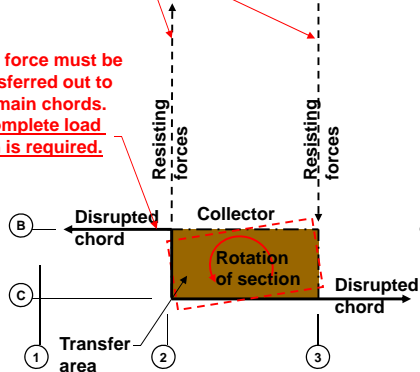

Transfer area without transverse collectors

Transfer Mechanism

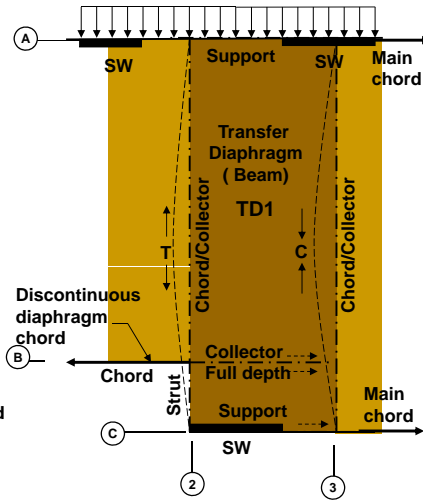

NOTE: Collector must extend the full depth of the transfer diaphragm

Transfer using beam concept

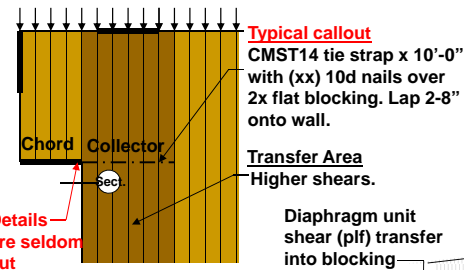

Plan-Partial length collector

- The length of the collector is typically determined by dividing the collector force by the diaphragm nailing capacity. (Wrong!!)
- The collector is typically checked for tension only. Compression rarely checked. (Wrong!!)

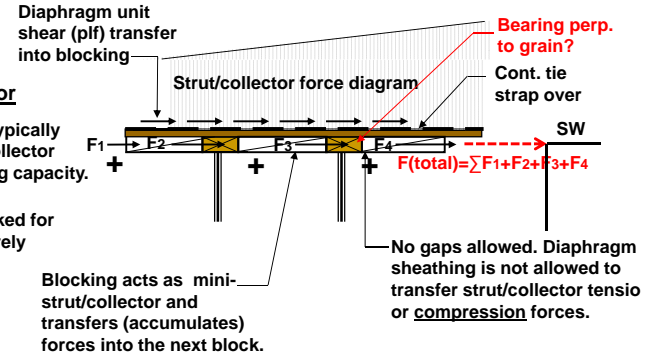

Collector force distribution

Example of Partial Strut/Collector

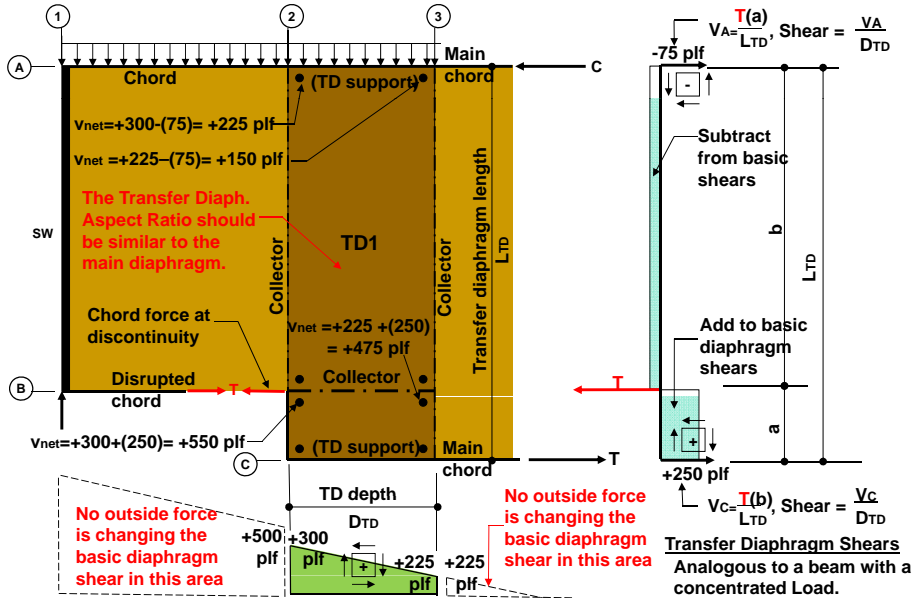

No outside force is changing the basic diaphragm shear in this area

No outside force is changing the basic diaphragm shear in this area

Basic Shear Diagram at transfer diaphragm

Basic Procedure

Method by Edward F. Diekmann

Transfer Diaphragm Shears Analogous to a beam with a concentrated Load.

$v_{net} = 300 + (250) = 550$ plf
Basic diaph. shear TD shears

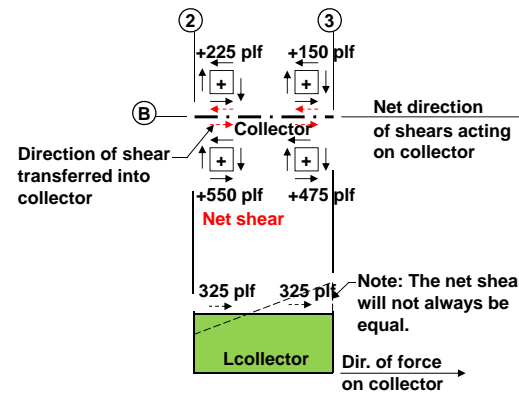

Resulting net shear diagram on collector

Shear Distribution Into The Collector

- Place the net diaphragm shear on each side of the collector
- Place the transfer shears on each side of the collector
- Sum shears on collector (based upon direction of shears transferred onto collector).

Shear left = +550 - 225 = +325 plf

Shear right = +475 - 150 = +325 plf

Collector force = $\frac{(325 + 325)(L_{collector})}{2}$

Diaphragms with Horizontal Offsets

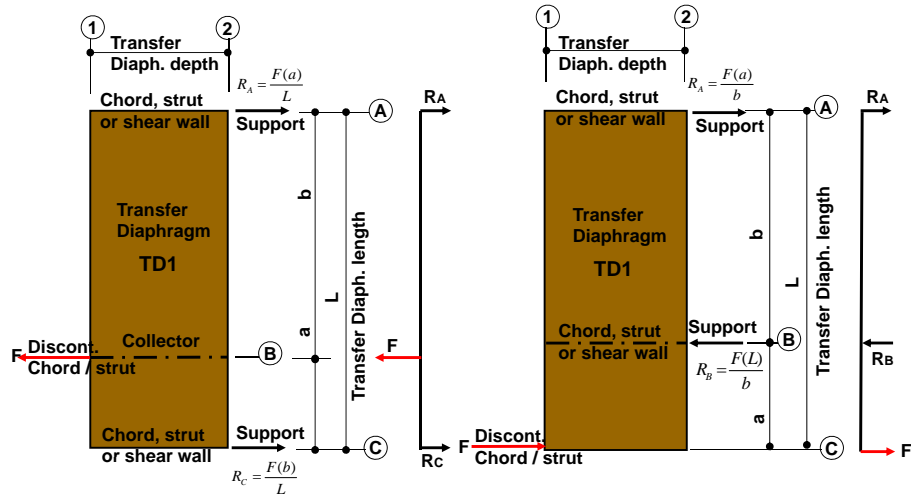

Simple Span Transfer Diaphragm

Analogous to a simple span beam with a concentrated load

Propped Cantilever Transfer Diaphragm

Analogous to a propped cantilever beam with a concentrated load

Simple Span and Propped Cantilever Transfer Diaphragms

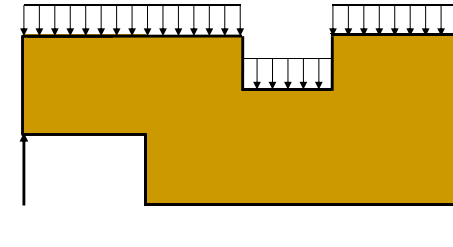

Example 1-Diaphragm with Horizontal End Offset

Transverse Loading

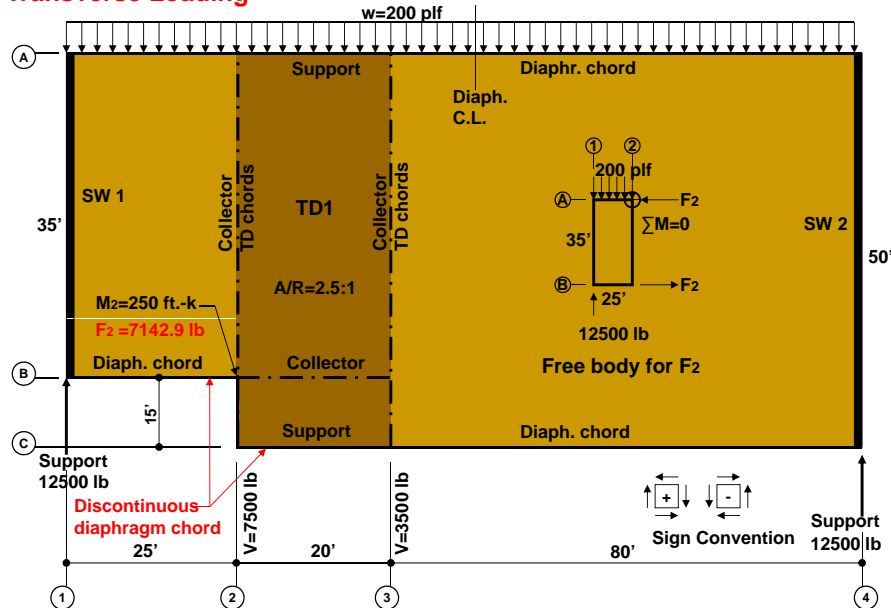

Transfer Diaphragm and Net Diaphragm Shear

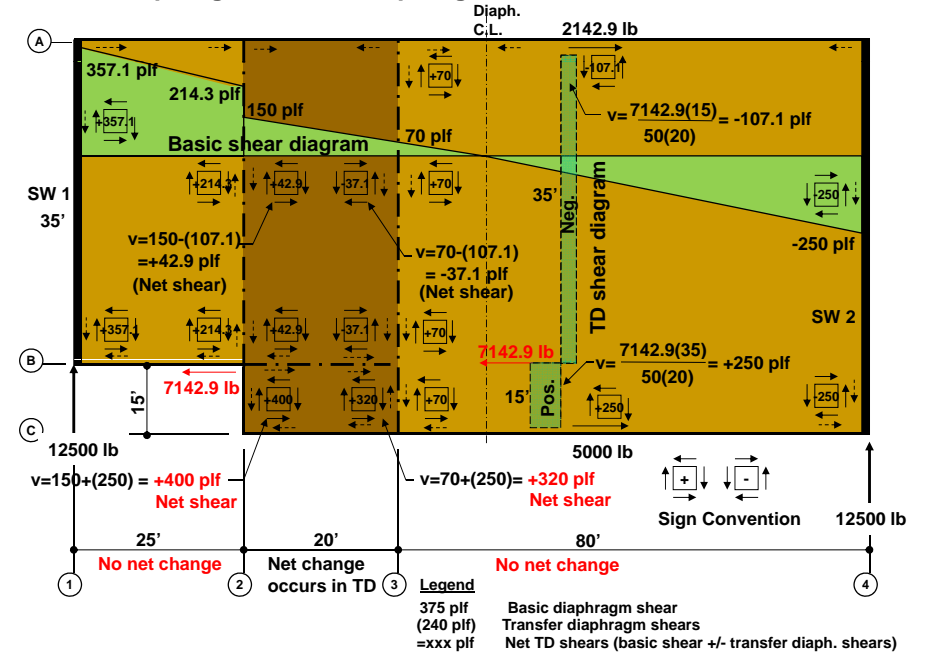

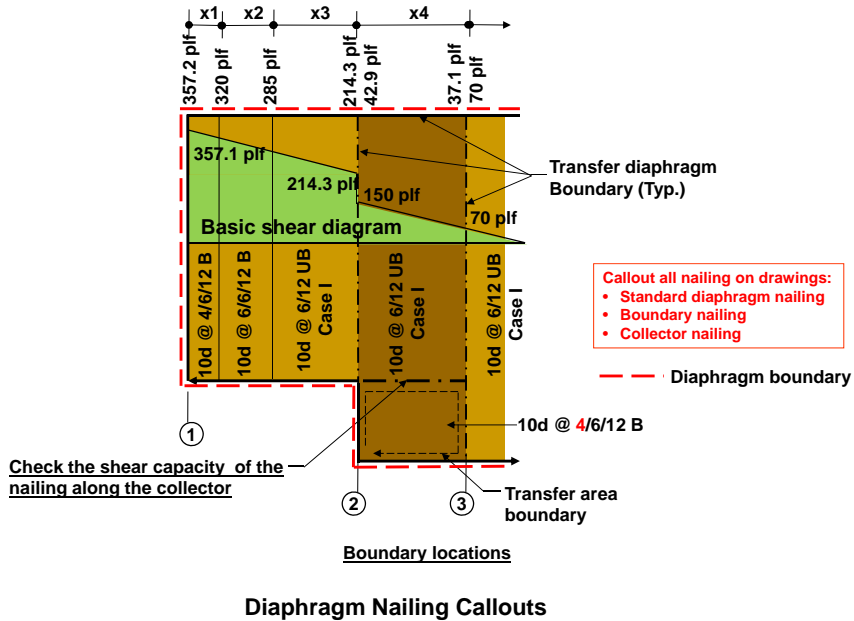
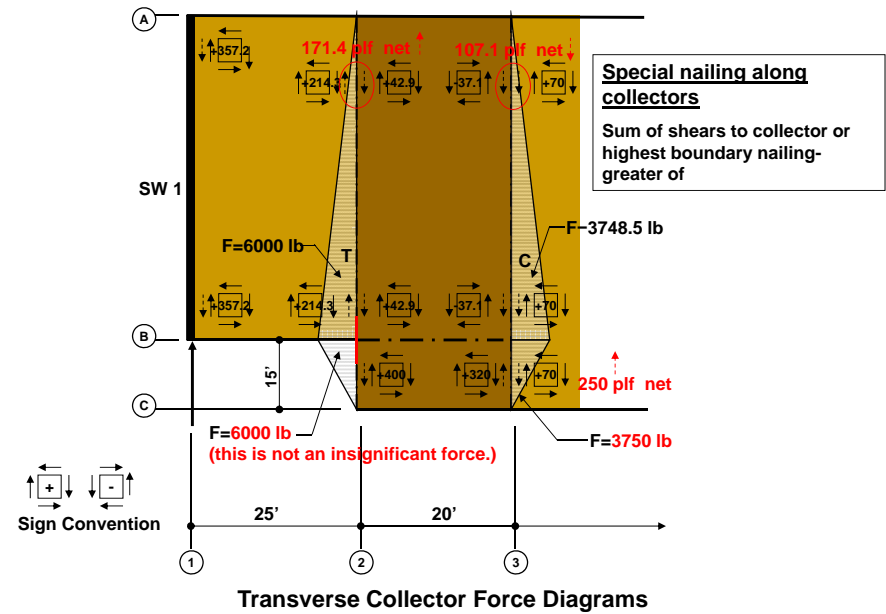
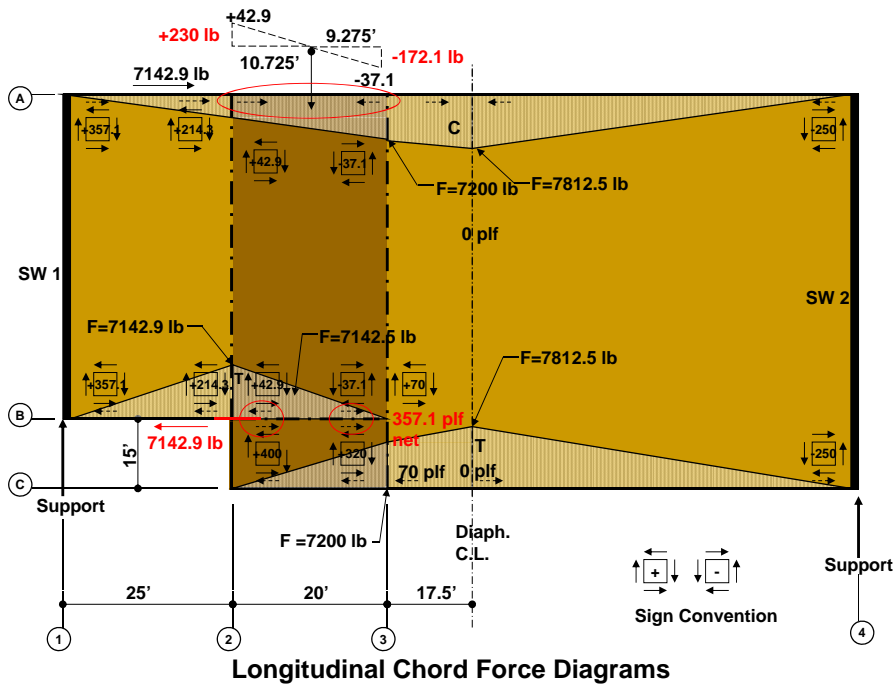

Example 2-Diaphragm with Horizontal End Offset
Longitudinal Loading

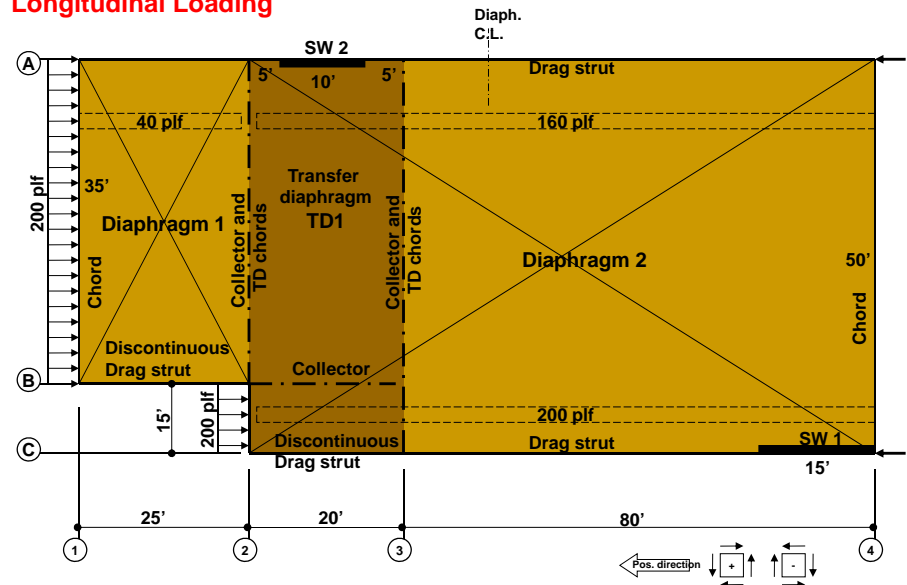

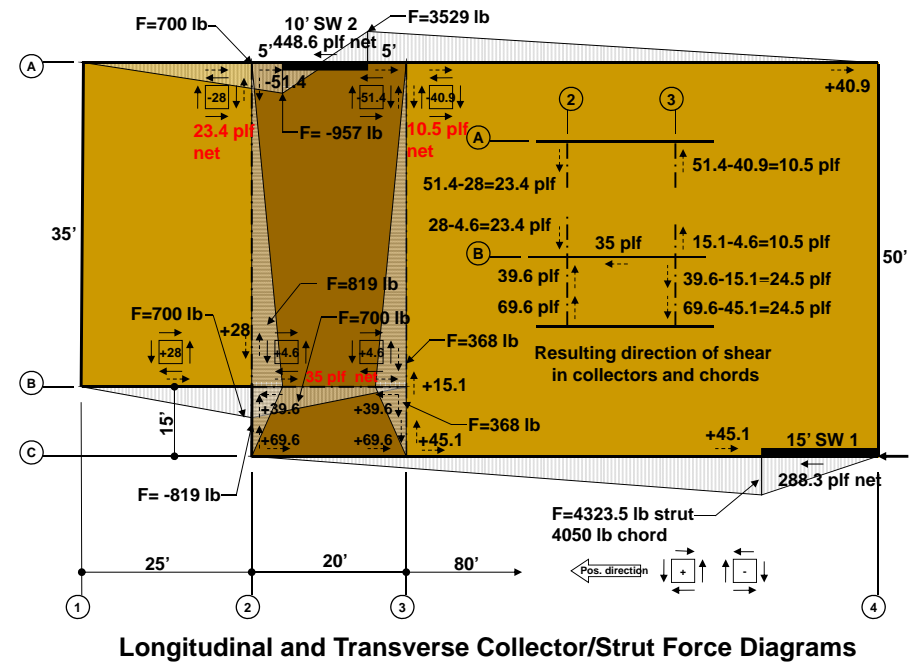
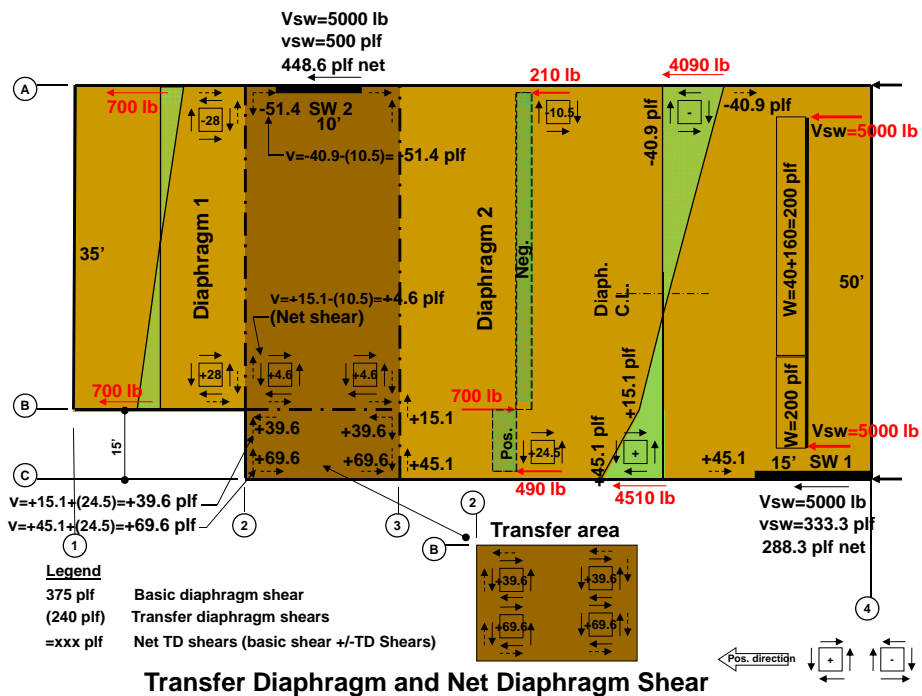

Questions?

This concludes

AIA Presentation Part 1- on Offset Diaphragms

R. Terry Malone, P.E., S.E.
Senior Technical Director
WoodWorks.org
Prescott Valley, Arizona

Contact Information:
terrym@woodworks.org

WoodWorks
woodworks.org
Events/Presentation Archives (slide handouts)-free